

665

RECEIVED 2280

AUG 12 2016

Nat. Register of Historic Places
National Park Service

United States Department of the Interior
National Park Service

National Register of Historic Places Registration Form

This form is for use in nominating or requesting determinations for individual properties and districts. See instructions in National Register Bulletin, *How to Complete the National Register of Historic Places Registration Form*. If any item does not apply to the property being documented, enter "N/A" for "not applicable." For functions, architectural classification, materials, and areas of significance, enter only categories and subcategories from the instructions.

1. Name of Property

Historic name: Miller Red Barn

Other names/site number: Christmas Hill Park Red Barn

Name of related multiple property listing:

N/A

(Enter "N/A" if property is not part of a multiple property listing)

2. Location

Street & number: 7049 Miller Avenue

City or town: Gilroy State: CA County: Santa Clara

Not For Publication: Vicinity:

3. State/Federal Agency Certification

As the designated authority under the National Historic Preservation Act, as amended,

I hereby certify that this x nomination request for determination of eligibility meets the documentation standards for registering properties in the National Register of Historic Places and meets the procedural and professional requirements set forth in 36 CFR Part 60.

In my opinion, the property x meets does not meet the National Register Criteria. I recommend that this property be considered significant at the following level(s) of significance:

 national statewide x local

Applicable National Register Criteria:

 x A B C D

	Deputy State Historic Preservation Officer
Signature of certifying official/Title:	Date
<u>California Office of Historic Preservation</u>	
State or Federal agency/bureau or Tribal Government	
In my opinion, the property <u> </u> meets <u> </u> does not meet the National Register criteria.	
Signature of commenting official:	Date
Title :	State or Federal agency/bureau or Tribal Government

Miller Red Barn
Name of Property

Santa Clara, CA
County and State

4. National Park Service Certification

I hereby certify that this property is:

- entered in the National Register
- determined eligible for the National Register
- determined not eligible for the National Register
- removed from the National Register
- other (explain:)

For Edson H. Beall *9-26-16*
Signature of the Keeper Date of Action

5. Classification

Ownership of Property

(Check as many boxes as apply.)

- Private:
- Public – Local
- Public – State
- Public – Federal

Category of Property

(Check only **one** box.)

- Building(s)
- District
- Site
- Structure
- Object

Miller Red Barn
Name of Property

Santa Clara, CA
County and State

Number of Resources within Property

(Do not include previously listed resources in the count)

Contributing	Noncontributing	
<u>1</u>	_____	buildings
_____	_____	sites
_____	_____	structures
_____	_____	objects
<u>1</u>	_____	Total

Number of contributing resources previously listed in the National Register _____

6. Function or Use

Historic Functions

(Enter categories from instructions.)

AGRICULTURAL/SUBSISTENCE

Current Functions

(Enter categories from instructions.)

VACANT

Miller Red Barn
Name of Property

Santa Clara, CA
County and State

7. Description

Architectural Classification

(Enter categories from instructions.)

OTHER: Barn (Western)

Materials: (enter categories from instructions.)

Principal exterior materials of the property: WOOD

Narrative Description

(Describe the historic and current physical appearance and condition of the property. Describe contributing and noncontributing resources if applicable. Begin with a **summary paragraph** that briefly describes the general characteristics of the property, such as its location, type, style, method of construction, setting, size, and significant features. Indicate whether the property has historic integrity.)

Summary Paragraph

The Miller Red Barn is a pole-constructed wooden hay barn built in 1891 on land owned at that time by the California cattle baron, Henry Miller. The Barn is a 25 foot high, 5,358 square foot vernacular barn, classified as a Western style barn, prevalent in the western United States where raising large herds of animals called for storing large amounts of feed.¹ The upper central part of the roof has a small raised monitor to provide ventilation between it and the sidelong, lower roofing. The windowless barn is distinguished by a wide, side to side gabled transept two-thirds toward the rear of the building to allow a drawn vehicle to pass through to unload its contents, and then exit on the opposing side without turning. Built in 1891, the barn is stable, not sagging or leaning. It is roofed with galvanized corrugated sheet metal installed in the early 1950s and has several storm-caused gaps that leave parts of the barn open to the weather. Parts of the roof have loosened at the edges. There is also a walled off 25 ft. by 56 ft. space in the rear north end of the building with a wooden floor which was used as storage for dried fruit, as well as temporary lodging for seasonal laborers. (See Photos 1, 2, 3, 4, and 5)

¹ US Department of the Interior, National Park Service, Technical Services, Preservation Brief 20, "The Preservation of Historic Barns." Michael J. Auer. Washington D.C. 1989. Accessed 2/7/16.
<http://www.nps.gov/tps/how-to-preserve/briefs/20-barns.htm>.

Miller Red Barn

Name of Property

Santa Clara, CA

County and State

Narrative Description

Barn Exterior

The exterior of the Barn is made of 9 ft. to 11 ft. high, 9 in. to 11 in wide redwood upright boards, battened with 2 in. to 2 ½ in. fir strips. The boards clearly show the curved striations from a circular saw typical of lumber rough- milled with a steam powered saw.

The north and south ends of the Barn show evidence of rectangular openings on the mid and upper levels, perhaps for ventilation, and are now sealed shut with boards and battens. On the north side, which measures 55 ft. 6 in. in length, there is evidence of a central, hinged double door, since sealed shut. To the east of this door is a 2 ft. x 2 ft. open electrical box containing non-functioning electrical meters and fragments of insulation. At the eastern end of the north side of the building, at the low-sloping end, is a 2 ft. by 3 ft. window now sealed shut with boards and battens. This window would have opened into the area of the interior of the Barn that is the floored, fruit storage and lodging-house end of the building. Around the corner on the east facing side is a small 4 ft. x 6 ft. door into the same area as the adjacent ground level window on the north side. This door is also sealed shut with boards and battens. Along the outer edge of the northern end of the Barn, and under the bottom edge of the redwood boards, is a 12 inch wide strip of cement which seems to serve as a splash back, or an attempt to impose a sill.

The east side of the Barn measures 95 ft. 7 in. in length. Starting at the north end, the walls consist of a 24 ft. span of 9 in. redwood boards and battens terminating at a 13 ft. x 4 in. wide door 11 ft. high, underneath a gable. The gable covers the east end of the 17 ft. wide transept that crosses the width of the building. The opening is covered with galvanized metal doors attached to the frame by modern hinges. There are three old hinges on the door frame on each side of the doorway, not attached to the door.

To the south of the gabled opening, there are four 8 ft. sections of boards and battens and another 5 ft. section of boards and battens at the southern end of the wall, which are reinforced with 4 in. x 4 in. wooden upright supports bolted to the framing of each individual section.

Midway along the length of the east side of the Barn is an upright rectangular box approximately 2 ft wide, 5 ft. high and a one ft. deep, set about 5 ft. away from the building's wall. It is painted a faded green, and contains connections supplying electricity to the area during the annual Garlic Festival which takes place at Christmas Hill Park during the last full weekend in July.

The south side, or the front of the Barn, measures 55 ft. 6 in. across, and the upright redwood boards are 10 in. wide. On the east end of the south front is a former doorway sealed over by boards and battens. The doorway measures 8 ft. wide x 10 ft high.

A great sliding door measuring 13 ft. 7 in. wide and 11 ft. high is located in the center of the South side. Above it on the second level is 2 ½ ft. x 3 ft. shuttered window sealed with battens. On the third level there is evidence of a 2 ft. x 3 ft. shuttered opening also sealed shut with battens.

Miller Red Barn
Name of Property

Santa Clara, CA
County and State

On the west end of the south side of the Barn is a galvanized metal sliding door measuring approximately 8 ft. x 10 ft. that is off its track and leaning against the opening.

The west side of the Barn measures 95 ft. and 7 in. 25 ft. from the South corner of the west side of the barn there is evidence of a small 2 ft. 6 in. x 5 ft. high door sealed by battens. Its purpose is unknown.

24 ft. from the north end of the west side is a great doorway under a gable measuring 13 ft. 4 in. and 11 ft. high which is the western end of the 17 ft. wide transept running across the width of the Barn. The doorway is covered three quarters the way up by new heavy 8 ft. upright boards, closing off the entrance to the Barn. There is also on the north edge of the door frame, a 4 in. x 6 in. wooden support fastened to the redwood boards next to the door frame with nails and a large metal bolt.

The long east and west sides of the barn show cement sills, some of which edge into the interior of the Barn, and some to the outside of the Barn. It is not known when they were laid down, but it looks as though they were installed after the Barn was built.

The whole of the Barn is surrounded by a 5 ft. iron fence about 6 ft. from the Barn itself. Its purpose is to protect the Barn from vandalism and to protect the City from liability loss.

Barn Interior

The following is taken from a 2014 structural evaluation report.² The construction of the barn looks to have been done in two phases. Phase A includes the Southern 35 feet of the structure towards the front or South. Phase B includes the rest of the barn which is approximately 61 feet.

All the lumber throughout the Barn is true size, cut to the actual dimensions cited, (vs. modern lumber which is trimmed to a smaller size.) The upper roof of both phases consists of corrugated metal on top of 1" x 8" slats spaced approximately 12" off center. The slats span 30" from 2" x 6" rafters.

Because of the consistency of the roofing materials replaced in the 1950s, it is not apparent from the exterior that the southern-most part of the building was added on at some later time.

² Stuart A. Scott, Registered Professional Engineer, State of California, No. S3890. *Structural Evaluation Report for Miller Red Barn, Christmas Hill Park, Gilroy, California.* Gilroy. 2014.

Miller Red Barn

Name of Property

Santa Clara, CA

County and State

Phase A. – The South end of the Barn.

The rafters span 13'2" from the ridge, where they are attached to the opposite rafter down to a 4"x 6", the 4"x 6" beam lying in the weak direction. The 4x8 beam then spans 9'-6" to 4x6 true size columns, 18'-0" above the ground. The roof slope is at a 12 on 6 pitch.

The lower roof for Phase A consists of the same corrugated roof with 1 x 8 slats about 12: off center spanning 30" over 2x 6 True Size rafters. These rafters span 18'-9" from a 2x8 ledger which spans from 6'-9" column to column, approximately 16 ft above ground. The other end of the rafter rests on the top of the 6'9" tall exterior wall. The top plate on the wall is two 2x4 True Size members in the weak direction.

The walls are the same redwood boards covering the exterior, and are of sturdy construction. (See Photos 7, 8 and 9)

Phase B – The back two-thirds of the Barn - emulates the same layout as Phase A, but is of much stronger construction.

The southern part of Phase B connects to Phase A to create a large open area. The middle part of Phase B has a wall which separates the large open area from a breezeway/corridor which is marked by the hip or gabled roofs seen from outside. The breezeway is about 17 ft wide and has a wall with a large opening in the center of the south side, and a wall with two smaller openings at each end on the north side. The north end of the building beyond the doored breezeway has a floored area of tongue and groove fir. In the center of the wall defining the floored area is an open window on a higher level with a hinged shutter.

On the southwest side of the corridor is a door into a space walled off from the large central Barn area. Its use is thought to be for equipment and perhaps animal feed storage.

Every 4th rafter is a truss. The truss consists of the 2 rafters plus a 2x6 true size bottom chord tying the rafters together. There is a king post of a 2 x 6 which runs vertically from the bottom chord to the top of the rafters. There is no blocking for the rafters. The columns for the trusses do not line up with the trusses. They are offset by about 6", about 9", and about 18".

The upper roof of Phase B consists of the same corrugated roof. The slats used are wide though of the same thickness. The rafters are space 24" (rather than the 30" in Phase A.) The span for the rafters is the same 13'-2" as in phase A, however Phase B does make use of a ridge beam, which provides a stronger connection, a more stable connection, and resistance to longitudinal loads, as well as providing a more positive connection to the truss. The other end of the rafter is similar to Phase A in that it rests on top of a 4 x 6 beam in the weak direction. Phase B has columns spaced at 8'-0" off center, (instead of the 9'-6" in Phase A). Also, the phase B columns are 6 x 6 true size where the columns in Phase A are only 6 x 4.

Miller Red Barn
Name of Property

Santa Clara, CA
County and State

The truss in Phase B is a substantial upgrade from phase A. The truss in Phase B consists of a 2 x 8 bottom chord. The bottom chord has additional braces down to the columns and the truss itself also has 3 1x8 interior members to support the load.

The lower roof for Phase B is essentially the same as that of Phase A.

The two Phases A and B are spliced together. There are rafters near the edge of each phase such that the rafters are about 14" to 16" away from each other. Above the rafters are splice pieces – the 2' x 6" pieces are attached to the tops of two consecutive rafters on the strong (Phase B) side, and attached to the face of the end rafter of the weak (Phase A) side.

Barn Roof

The corrugated metal roof, installed to replace shingles in the 1950s, shows deterioration due to lack of maintenance. The wind, rain, and age have caused the sheets to curl and stress their connections to the slats and rafters, which have ultimately caused the connections to fail, and caused the corrugated roof material to curl some more and pull away from the slats, resulting in holes.

Lower Roof Structure

The lower roof structure for Phase A and Phase B are relatively the same. Phase A has rafters spaced at 30" on center and Phase B has rafters spaced at 24" on center so the rafters in Phase A carry 25% more tributary area than Phase B. This is why all of the rafters in Phase A have some sort of improvised vertical support and some of the Phase B rafters have additional vertical support installed at a later time.

The redwood lumber mostly looks in good shape. There are probably pieces that are inadequate due to exposure to sun, wind and rain. There is additional potential for damage caused by sustained lack of support. The supports that are there, are there because at some point, there was too much deflection in the members.

Miller Red Barn

Name of Property

Santa Clara, CA

County and State

Historic Integrity

Location: The Miller Red Barn has retained its historic integrity in the area of location because it is located on the exact space on which it was built on the Glen Ranch.

Design: The Miller Red Barn has retained its historic integrity in the area of design because there are no indications that the structure has been modified for any other use, and the layout reflects the criteria of the 1891 barn built by Henry Miller described in the San Jose Evening News.

Setting: The Miller Red Barn has retained its historic integrity in the area of setting because the wide open park land upon which it sits reflects the same sense of place where fruit, vines, and at times, hay once grew. The area is now park land but retains its generally rural setting.

Materials: The Miller Red Barn retains its integrity of materials because they are the original materials commonly used in 19th century utilitarian structures. The corrugated metal roof which replaced wooden shingles represents a limited loss of integrity of materials, but the property retains sufficient integrity of materials to remain eligible under Criterion A.

Workmanship: The Miller Red Barn has retained its historic integrity of workmanship. It is simply made in the utilitarian manner of its day, and while it has some special differences in design, the structural methods used were common to barns, and the building has been never “upgraded” to any other use.

Feeling: The Miller Red Barn has retained integrity of feeling. The Barn is still an agricultural building that reflects the work done in the era of the Glen Ranch, 1891 to 1941.

Association: The Miller Red Barn retains its historic integrity of association with the Glen Ranch and its agricultural functions because, purpose-built for processing fruit, the Barn has never been altered to any other use, making its association with that historic use clear. If cattle baron Henry Miller, builder of the barn, walked into the Barn today, would instantly recognize the building as that which he had built in 1891.

Miller Red Barn
Name of Property

Santa Clara, CA
County and State

8. Statement of Significance

Applicable National Register Criteria

(Mark "x" in one or more boxes for the criteria qualifying the property for National Register listing.)

- A. Property is associated with events that have made a significant contribution to the broad patterns of our history.
- B. Property is associated with the lives of persons significant in our past.
- C. Property embodies the distinctive characteristics of a type, period, or method of construction or represents the work of a master, or possesses high artistic values, or represents a significant and distinguishable entity whose components lack individual distinction.
- D. Property has yielded, or is likely to yield, information important in prehistory or history.

Criteria Considerations

(Mark "x" in all the boxes that apply.)

- A. Owned by a religious institution or used for religious purposes
- B. Removed from its original location
- C. A birthplace or grave
- D. A cemetery
- E. A reconstructed building, object, or structure
- F. A commemorative property
- G. Less than 50 years old or achieving significance within the past 50 years

Miller Red Barn
Name of Property

Santa Clara, CA
County and State

Areas of Significance

(Enter categories from instructions.)

AGRICULTURE

Period of Significance

1891 – 1941

Significant Dates

1891 – Construction of Barn

1941 – Sale of the Glen Ranch from the Henry Miller Estate

Significant Person

(Complete only if Criterion B is marked above.)

Cultural Affiliation

Architect/Builder

Statement of Significance Summary Paragraph (Provide a summary paragraph that includes level of significance, applicable criteria, justification for the period of significance, and any applicable criteria considerations.)

The Miller Red Barn is eligible under Criterion A at the local level of significance in the area of agriculture, for its association with the extensive prune, apricot, and wine grape production in south Santa Clara County as part of the agricultural holdings of Henry Miller, partner in the San Francisco cattle raising and meat packing partnership of Miller & Lux. The period of significance is from 1891, when the Barn was built to service tree and wine growing crops and their harvest through 1941, the year the Glen Ranch with the Barn was sold from the Henry Miller estate.

Miller Red Barn

Name of Property

Santa Clara, CA

County and State

Narrative Statement of Significance (Provide at least **one** paragraph for each area of significance.)

The Miller Red Barn is a hay barn built in 1891 with design adaptations made specifically for processing summer tree fruits. Miller's adaptation of the Miller & Lux business-style, designed for systematic, industrial-level cattle-raising, to fruit-raising at what Miller called the "Glen Farm" led him to build the Barn to process and store large quantities of fresh and dried fruit. The Barn was erected in response to the need for a larger facility to pack and store the quantity of fresh and dried tree fruit produced at the Glen and its associated properties. The Barn was also planned to be used as lodging for seasonal workers. In the early 1900's, the Glen Farm's production was shifted from tree fruit to wine grape growing, and in 1906, due to Santa Clara County's wine growing business migrating to south Santa Clara County, Miller leased the Glen Farm to the California Wine Association for 15 years. In 1941, the Glen Farm was purchased by the San Martin Winery, which continued to use the Barn for viticultural purposes for many years.

The Barn is remarkable for its large 5,358 square foot size, and the gabled 17 foot wide lateral passage toward one end of the building which is unique for barns in this area. The design of the 35 ft. x 95 ft. floored, enclosed rear part of the Barn, a set aside for dried fruit storage and for its use as temporary lodging for seasonal workers, is not found in any other barn in Santa Clara County. Miller's adoption of the Miller & Lux business-style, designed for systematic, industrial-level cattle-raising,³ and fruit-raising at the Glen Farm, led him to build this Barn to process and store large quantities of fresh and dried fruit.⁴

The Miller & Lux partnership consisted of Charles Lux and Henry Miller who, in the 1860s to the early 1900s, created a business to supply the expanding markets in San Francisco with quality meat, raised largely in California's Central Valley. Both men were trained in their native Germany as butchers.⁵ Miller ran the ranching, land, and water acquisition end of the business, and Lux was responsible for finance and the meat processing operations in San Francisco. They acquired huge amounts of California Central Valley land as well as large tracts in Nevada and Oregon for grazing cattle and other meat animals. They also acquired or controlled most of the water rights in the San Joaquin Valley.

³ David Iglar. *Industrial Cowboys: Miller & Lux and the Transformation of the Far West, 1850-1920*. Berkeley: University of California Press, 2001. 40, 58-59. Miller & Lux's business method was to buy increasing amounts of land and to control increasing sources of water to support more and more cattle, and then drive the cattle from the San Joaquin Valley to San Francisco in quantities large enough to swamp the SF wholesale market with better meat and lower prices.

⁴Gilroy Advocate. September 19, 1891. "The glen Ranch will produce in dried fruits this year about 12 tons of prunes, 4 tons of peaches, 2 tons of pears, 1½ tons of apples, 2 tons of walnuts, 1 ton of plums, and 3 tons of raisins."

⁵ Iglar, 13.

Miller Red Barn

Name of Property

Santa Clara, CA

County and State

Henry Miller himself owned 12,335 acres of the Las Animas Rancho in southern Santa Clara County at the western base of the Pacheco Mountains. The pass through these mountains was the corridor between the Santa Clara and San Joaquin Valleys, the latter being the source of the cattle Miller raised. Miller established his "home place" at its western end in Santa Clara County south of Gilroy. He called this establishment the Bloomfield Farm. He divided "the Farm" into four parts, one of which was the Glen Farm lying to the west of the City of Gilroy where the Miller Red Barn sits.

Miller's move into fruit -raising was unusual – he was born in Germany and trained as a butcher and vendor of meat animals. He built his business empire based on those skills. But he had an unusually intelligent mind.⁶ He had a ferocious memory – able after some little thought to tell you what he paid for a herd of cattle he bought forty years before. He could constantly calculate what costs were. He was frugal, very pragmatic, and did not like waste, what we would call today a micro-manager. Miller was also forward thinking. He worked for several years to get the railroad to bring a line down to Los Banos so he would not have to drive cattle over Pacheco Pass and up El Camino Real to San Francisco. And he worked out well ahead what he would do with the Glen when he didn't need to use it to pasture resting cattle mid- drive. He also had legal business in San Jose, was thoroughly familiar with the developing business of fruit growing in Santa Clara County, and talked with many people who were invested in horticulture.

Horticulture in Santa Clara County

When the treaty of Guadalupe Hidalgo was signed in 1848 at the end of the Mexican American war, Mexican-owned California and other Mexican-claimed North American territories were ceded to the United States. Months later, the discovery of gold brought on the great gold rush to California. The first Americans arriving in the San Jose area from across the plains were stunned to see fruit trees growing in the walled gardens of the Spanish Missions. American civil authorities had to establish resident armed guards to protect the Missions and their orchards from squatters and fruit thieves, starved for fresh fruit. It was not too long after this that some forty-niners, either successful in, or tired of the gold fields, began to look around for a likely location on which to settle and found Santa Clara County a good place. Seeing the success of the fruit trees growing at the missions, some of these settlers imported fruit tree cuttings from horticulturists on the East Coast. While most planted on their homestead for personal use, some also bought for others also, and soon went into business. Commercial orchards began to be planted to supply fruit tree cuttings to settlers who found that fruit trees grew exceedingly well.

During the 1860's, at random, and then in growing numbers, orchards of deciduous fruit trees were dotted out among the hay and wheat fields that were the dominating crops in the Santa Clara Valley at that time and well into the 1890's. In the 1870's, not only hay was grown, but then alfalfa was raised in support of the newly developing dairy industry in the southeastern part of Gilroy where water was available from artesian wells.. Still, grain production prevailed as it did not require irrigation, and not all areas of South County had access to irrigation. But all the time, the number of peach, plum, and apricot orchards were increasing in number, as people fell

⁶ Iglar, 17, 19-20.

Miller Red Barn

Name of Property

Santa Clara, CA

County and State

in love with and the market supported these beautiful summer fruits. Strawberries and blackberries were also grown, made possible by the availability of water from a creek or wells. So successful was fruit farming that there was more fruit harvested than the market could handle and people began to dry fruit for shipping to the eastern United States and European markets. It was the start of the dried fruit industry.⁷

The fruit growing bonanza of the 1880s was the result of a confluence of several conditions.⁸ The first condition was the deep alluvial soils in the Santa Clara Valley in which highly fertile earth had evolved over eons by mineral rich dirt being rain-washed from the mountain sides into what became the Santa Clara valley. Then there was the availability of water remaining in the soil by winter rains, or by newly realized artesian well production. Thirdly, was the unique Santa Clara Valley climate in which the weather allowed an extended growing season, was seldom too hot or too cold, and supplied plenty of sun most of the year.

The fourth condition that fostered the highly successful fresh and dried fruit business was the transportation revolution that occurred when in the late 1860s the railroad opened the way for produce to be delivered away from the local area into regional markets. Suddenly, farmers were not only supplying fruit to local civilians and fresh-food starved miners, but to an ever expanding local population moving westward into San Francisco and San Jose via the newly opened transcontinental railroad. In reverse, the transcontinental railroad also enabled dried fruit to be shipped to Eastern and European markets.

The final condition that made the bonanza possible was that banks were quite willing to make loans at very reasonable rates to entrepreneurial farmers, eager to join the fruit bonanza by buying what was then inexpensive land and then setting up a fruit growing operation. Within four years, one would be selling fruit into a growing market at high prices, allowing one to pay off the loans. Also, when the quantities of harvested fruit proved to be more than the market could absorb, farmers were learning how to dry the excess fruit for which there evolved an exceptional demand. The increasing demands upon the orchardist to get his produce to market resulted in the creation of specialty agencies to market fruit, especially to the East, from which there were unusual profits to be made.

The French Prune that came to dominate the fruit producing culture in Santa Clara County in the late 1800s and into the middle of the 20th century was a small plum, the cuttings of which were originally imported by the Pellier brothers into San Jose in the 1850s. This small plum was mostly ignored by early fruit growers until they figured out that they could successfully dry the fruit without removing the pit. Most fruit requires that the pit be removed to keep the flesh from rotting. "Prunes" became the most successful crop in Santa Clara County, the next largest being the annual production of apricots which was half the quantity of the prune's annual crop. The success of each was determined by its ability to be dried and still appear appetizing. When the increase in the number of orchardists raising these fruits produced a flooding of fruit on the

⁷ Robert Couchman. *Sunsweet Story*. San Jose. Sunsweet Growers, Inc. 1967. 9-10.

⁸ Couchman. 17.

Miller Red Barn

Name of Property

Santa Clara, CA

County and State

market forcing the prices to drop dramatically, growers learned to dry the prunes for which there developed a large market in the eastern United States and in Europe.

Henry Miller's building a barn for fruit processing at his Glen Farm was very unusual, since he wasn't a fruit farmer. Miller became known as California's cattle king by developing cattle-raising to an industrial level. The Miller & Lux partnership consisted of Charles Lux and Henry Miller who in the 1860s to the early 1900s, created a business to supply the expanding markets in San Francisco with quality meat raised largely in California's Central Valley. Miller ran the ranching, land and water acquisition end of the business, and Lux was responsible for finance and the meat processing operations in San Francisco. They acquired huge amounts of California Central Valley land as well as large tracts in Nevada and Oregon for grazing cattle and other meat animals. They also acquired or controlled most of the water rights in the middle part of the State of California's central San Joaquin Valley in order to irrigate the extensive pastures.

A German trained butcher, Miller arrived in San Francisco in 1850. He soon had his own butcher shop, and determined to find the source of the better meat he was buying, found his way to the southern part of Santa Clara County. By the late 1860s he had purchased the land rights to most of the Las Animas Rancho, and established his "home place" at this western end of the Pacheco pass that led to the San Joaquin Valley where he was establishing an expanding cattle raising operation. He called his home the "Bloomfield Farm", and divided it up into four parts, one of which was to the west of Gilroy, and was called the "Glen Farm." While it was his home base in the countryside, Miller used the Bloomfield in its entirety to rest cattle driven in stages from the San Joaquin Valley on their way to the processing house in San Francisco. The Glen ranch was used largely for pasturing resting cattle and hay production. It was here, in later years, that he built the large barn for fruit processing.

The reference to Miller's interest in growing fruit at the Glen Farm is a map drawn by A. T. Hermann in 1875 which shows a 26.75 acre portion of the 200 acre Glen Ranch marked separately as the "Orchard Field" along the Uvas/Carnadero Creek, north of the current location of the Barn.⁹ The area was typical of the land Miller sought to acquire to pasture cattle, with plenty of grass and a reliable source of water in the Uvas/Carnadero Creek. But the land was also perfect for horticulture with its never-touched alluvial soils, so he began to experiment with fruit raising.

In 1886 a Gilroy Board of Trade promotional publication described the variety of Miller's deciduous fruit tree plantings, and the acreage devoted to each.¹⁰ The total acreage of all varieties of fruit trees, including also that used to raise grapes, amounted to 132 acres. At that time Miller was planting trees on the bench lands surrounding the Glen. Eventually, orchard acreage ran to Gilroy's western city limits, four short blocks from Gilroy's downtown Monterey St., and Miller was well and truly involved with the fresh and dried fruit bonanza in Santa Clara County.

⁹ See Map Log, Figure 0003, Survey Map executed for H. Miller by A. T. Herman.

¹⁰ E. S. Harrison. Gilroy, the Most Favored Section of Santa Clara Valley. Gilroy Board of Trade. 1885.

Miller Red Barn

Name of Property

Santa Clara, CA

County and State

Aside from the large quantity of fruit that required a larger facility to prepare for shipping, the probable impetus for building the Barn at the Glen in 1891 was the arrival, after many years of negotiation, of the railroad in 1889 to Los Banos,, Miller's San Joaquin Valley headquarters¹¹. Now cattle could be shipped directly by rail from there to the Miller & Lux abattoir in the East Bay across from San Francisco. No longer did cattle have to be driven over Pacheco Pass to the Bloomfield Farm and rested before being driven to San Francisco, freeing up pasturage at the Glen Farm for fruit raising.

Miller moved into fruit growing somewhat carefully, planting a wide variety of fruit trees including olives at a confined 26 acre area of the Glen before 1875. Eventually, like others in the area, he specialized in prunes for drying, and while he never stopped growing prunes, in the end he dedicated most of his acreage to growing wine grapes.

Wine Growing

At the same time that deciduous fruit growing was evolving in Santa Clara County, wine grape growing and wine making businesses were also developing. With the arrival of the Spanish missionaries into California, wine grapes were grown at the Missions, and when the Gold Rush brought people from countries with a culture of wine drinking, vineyards began to be planted in the San Jose area. By the 1880s and 1890s, along with apricot and prune growing, grape growing and wine making were big business.¹²

At the end of the 1890s, grape prices were high, but the harvests in the northern section of Santa Clara County were increasingly poor due to the infestation of the vines with the phylloxera louse that invades the roots of the vines, and causes fewer grapes to form. It was serious enough that growers were looking for fresh ground to establish new vineyards, and began to plant in South Santa Clara County using St. George phylloxera-resistant root stock. The small family wineries already established in the Gilroy area could not utilize the quantities of grapes they grew, and most of these southern Santa Clara County grapes had been shipped to the wineries in San Jose.¹³

Somewhere between 1891 and 1898, Miller changed his focus from stone fruit to grapes. In 1904, he sold 1500 tons of grapes to the California Wine Association, a powerful merchants' association capable of setting prices in the region.¹⁴ Since it takes four years or more to bring a vine into production, Miller had to have planted vines several years previously to harvest this quantity of grapes.¹⁵

¹¹ Wayne Pimental. *Dogtown and Ditches - Life on the West Side*. Los Banos California. Loose Change Publications. 61, 71.

¹² Couchman, 9-10.

¹³ Charles L. Sullivan. *Like Modern Edens: Winegrowing in Santa Clara Valley and Santa Cruz Mountains 1798 - 1981*, California History Center, 1982. 104.

¹⁴ Ibid.

¹⁵ Ibid.

Miller Red Barn

Name of Property

Santa Clara, CA

County and State

Grape production in the Gilroy area was becoming so great that in 1905 the CWA closed its San Jose wine making plant and built the Las Animas Winery three miles north of Gilroy.¹⁶ It was Miller, the man notorious for never selling land, who sold six acres of land to the CWA for the new winery facility. In 1906 Miller signed a fifteen year lease for the Glen Ranch and other acreage totaling 700 acres with the CWA. Ten years later, in April 1916, five years before the lease expired, Henry Miller passed away.

San Martin Winery

In the meantime, in 1905, at the height of the boom in grape prices, a group of investors in San Jose, in opposition to the controlling methods of the California Wine Association, bought 200 acres in San Martin, an unincorporated area north of Gilroy, to raise wine grapes¹⁷ With their first harvest in 1908, they established the San Martin Wine Company and subsequently sold their own wine. The business remained in existence until 1929 when the Volstead Act was passed, which prohibited the sale of alcoholic beverages in the United States. In 1933, in anticipation of the revocation of Prohibition, the San Jose family of Bruno Filice purchased what was the now defunct San Martin Wine Company, and renamed it the San Martin Winery.¹⁸

In August of 1941, the Henry Miller estate sold the Glen Ranch to the Filice family. They continued to grow wine grapes there for more than thirty years to supply their family's San Martin Winery, which became known as one of the first wineries in the area to bottle wine by grape varietal. When the winery was sold in 1974, the Glen Ranch continued to provide wine grapes to the new owners of the San Masrtin Winery for another five years. In 1980, the contract with the San Martin Winery was not renewed. The Glen vineyard was pulled out and the land was leased to a local farm business that grew row crops. The Barn ceased to be used for the purpose it was created, and was used only for storing machinery.

In 1962, part of the Glen Farm was deeded by an interim owner to the City of Gilroy which used the gift to create the public Christmas Hill Park. Subsequently, the park was used during summers for the two- day Gilroy Garlic Festival. When high attendance became an issue, in 1990, with the help of the Garlic Festival Association, the City bought from the Glen-Loma interests the part of the Glen "Ranch" contiguous to Christmas Hill Park that holds the Barn. For some years the City allowed the Garlic Festival to store event signs in the Barn, but then became concerned about the stability of the building's structure and closed down any occupancy of the building.. In 2013, the City made the decision to demolish the Barn. The public became concerned, and a movement began to preserve and rehabilitate it.

¹⁶ Ibid.

¹⁷ Ibid.

¹⁸ Sullivan, 104.

Miller Red Barn

Name of Property

Santa Clara, CA

County and State

9. Bibliographic References

Bibliography (Cite the books, articles, and other sources used in preparing this form.)

Couchman, Robert. *Sunsweet Story*. San Jose, CA: Sunsweet Growers Inc., 1967.

Harrison, E. S. Gilroy, the Most Favored Section of Santa Clara Valley. Gilroy Board of Trade. 1885.

Igler, David. *Industrial Cowboys: Miller & Lux and the Transformation of the Far West, 1850-1920*. Berkeley: University of California Press, 2001.

Jacobson, Yvonne. *Passing Farms and Enduring Values*. Los Altos, California: William Kaufmann, Inc., 1984.

Pimental, Wayne. *Dogtown and Ditches – Life on the West Side*. Los Banos California. Loose Change Publications, 1987.

Ryan, Mary Ellen and Breschini, Gary S.. *The California Cattle Boom, 1849-1862*, Monterey, CA: Monterey County Historical Society, 2010.

Sawyer, Eugene Taylor. *History of Santa Clara County, California, with biographical sketches of the leading men and women of the county who have been identified with its growth and development from the early days to the present*, Los Angeles, California: Historic Record Company, 1922.

Shortridge, Charles. *Sunshine, Fruit and Flowers: Santa Clara County and Its Resources and Historical Descriptive and Statistical, a Souvenir of the San Jose Mercury*. [1895] San Jose Historical Association. 1966.

Stuart A. Scott, Structural Engineer. *Structural Evaluation Report for Miller Red Barn, Christmas Hill Park, Gilroy, California*. 2014.

Sullivan, Charles L. *Like Modern Edens: Winegrowing in Santa Clara Valley and Santa Cruz Mountains 1798 – 1981*, California History Center, 1982.

US Department of the Interior, National Park Service, Technical Preservation Services, Preservation Brief 20, “The Preservation of Historic Barns,” by Michael J. Auer, Washington D.C. 1989. Accessed 2/7/16.

<http://www.nps.gov/tps/how-to-preserve/briefs/20-barns.htm>.

Miller Red Barn

Name of Property

Santa Clara, CA

County and State

Waldschmidt-Nelson, Britta. "Henry Miller: The Cattle King of California." In *Immigrant*

Entrepreneurship: German-American Business Biographies, 1720 to the Present, vol. 2, edited by William J. Hausman. German Historical Institute. Last modified September 05, 2013.

Accessed February 15, 2016. <http://www.immigrantentrepreneurship.org/entry.php?rec=153>

Wyman, Beth. *Henry Miller's Bloomfield Ranch in Gilroy, California 1858-1916*, Research paper, 1976. Located at Gilroy Historical Museum, 195 Fifth Street, Gilroy California 95020.

Gilroy Advocate (CA) Filmed archive at Gilroy Historical Museum, 195 Fifth St, Gilroy California 95020:

For Orchardists - Number of trees on an acre at various distances. January 17, 1885

Glen Ranch will produce in dried fruits this year about 12 tons of prunes. September 19, 1891.

Henry Miller's Land – The undersigned have been authorized to offer. January 16, 1897.

Grapes To Be Shipped This Year. August 20, 1904.

Gilroy Winery To Be Built. August 24, 1904.

Glen Ranch Leased. May 26, 1906.

San Jose Mercury News Historical Archive (1886-1922).

[San Jose] Evening News:

Gilroy Improvements – Henry Miller will soon commence work. May 9, 1891.

Gilroy May Be a Wine Center. April 26, 1906.

Grapes Gathered Rapidly. October 9, 1914.

Olives Give Way To Prunes. October 9, 1914.

Evening News. (San Jose CA). 1891. San Jose Mercury News Historical Archive (1886-1922). San Jose, California.

Filice, Timothy, CEO Glen-Loma Group. February 19, 2014. Interview by author. Gilroy California.

Gilroy Advocate (CA). 1868 to 1949. Filmed archive at Gilroy Historical Museum, 195 Fifth St, Gilroy, California 95020.

Miller Red Barn
Name of Property

Santa Clara, CA
County and State

Previous documentation on file (NPS):

- preliminary determination of individual listing (36 CFR 67) has been requested
- previously listed in the National Register
- previously determined eligible by the National Register
- designated a National Historic Landmark
- recorded by Historic American Buildings Survey # _____
- recorded by Historic American Engineering Record # _____
- recorded by Historic American Landscape Survey # _____

Primary location of additional data:

- State Historic Preservation Office
- Other State agency
- Federal agency
- Local government
- University
- Other
- Name of repository: _____

Historic Resources Survey Number (if assigned): _____

10. Geographical Data

Acreeage of Property Less than one acre.

Use either the UTM system or latitude/longitude coordinates

Latitude/Longitude Coordinates (decimal degrees)

Datum if other than WGS84: _____
(enter coordinates to 6 decimal places)

1. Latitude: 36.998267 Longitude: -121.588334

Verbal Boundary Description (Describe the boundaries of the property.)

The boundary of the property is the immediate location of the barn.

Boundary Justification (Explain why the boundaries were selected.)

The boundary is justified by the immediate location of the barn.

Miller Red Barn
Name of Property

Santa Clara, CA
County and State

11. Form Prepared By

name/title: Carol A. DeSantis
organization: Miller Red Barn Committee
street & number: 1055 Monte Bello Dr.; Apt. A-110
city or town: Gilroy state: California _____ zip code 95020
e-mail cdesantis2000@gmail.com _____
telephone 408-612-6631
date April 5, 2016

Additional Documentation

Submit the following items with the completed form:

- **Maps:** A **USGS map** or equivalent (7.5 or 15 minute series) indicating the property's location.
- **Sketch map** for historic districts and properties having large acreage or numerous resources. Key all photographs to this map.
- **Additional items:** (Check with the SHPO, TPO, or FPO for any additional items.)

Photographs

Submit clear and descriptive photographs. The size of each image must be 1600x1200 pixels (minimum), 3000x2000 preferred, at 300 ppi (pixels per inch) or larger. Key all photographs to the sketch map. Each photograph must be numbered and that number must correspond to the photograph number on the photo log. For simplicity, the name of the photographer, photo date, etc. may be listed once on the photograph log and doesn't need to be labeled on every photograph.

Miller Red Barn

Name of Property

Santa Clara, CA

County and State

Photo Log

Photo Log

Name of Property: Miller Red Barn
City or Vicinity: Gilroy
County: Santa Clara
State: California
Name of Photographer: Margaret Aron
Location of Original Digital files: 1055 Monte Bello Drive, Apt. A-110, Gilroy CA 95020

Photo #1 of 9 (CA_Santa Clara County_MillerRedBarn-0001)
Barn Site across sports field, camera facing northwest.

Photo #2 of 9 (CA_Santa Clara County_MillerRedBarn-0002)
West Side of Barn, camera facing east.

Photo #3 of 9 (CA_Santa Clara County_MillerRedBarn-0003)
East Side of Barn, camera facing west.

Photo #4 of 9 (CA_Santa Clara County_MillerRedBarn-0004)
South Side of Barn, camera facing north.

Photo #5 of 9 (CA_Santa Clara County_MillerRedBarn-0005)
North Side of Barn, camera facing south.

Photo #6 of 9 (CA_Santa Clara County_MillerRedBarn-0006)
Interior of Crossing, camera facing east.

Photo #7 of 9 CA_Santa Clara County_MillerRedBarn-0007)
Interior of enclosed storage/lodging space, north end of Barn, camera facing east.

Photo #8 of 9 CA_Santa Clara County_MillerRedBarn-0008)
Interior of main space facing north into interior of Crossing, camera facing north.

Photo #9 of 9 CA_Santa Clara County_MillerRedBarn-0009)
Interior of main space facing east, showing differing roof structure and trusses, joining between both structural sections, and vents between upper and lower rooves, camera facing southwest.

Paperwork Reduction Act Statement: This information is being collected for applications to the National Register of Historic Places to nominate properties for listing or determine eligibility for listing, to list properties, and to amend existing listings. Response to this request is required to obtain a benefit in accordance with the National Historic Preservation Act, as amended (16 U.S.C.460 et seq.).

Estimated Burden Statement: Public reporting burden for this form is estimated to average 100 hours per response including time for reviewing instructions, gathering and maintaining data, and completing and reviewing the form. Direct comments regarding this burden estimate or any aspect of this form to the Office of Planning and Performance Management, U.S. Dept. of the Interior, 1849 C. Street, NW, Washington, DC.

United States Department of the Interior
Here
National Park Service

National Register of Historic Places

Miller Red Barn

Name of Property

Santa Clara County California

County and State

Name of multiple listing (if applicable)

Section number Additional Documentation Page 1

FIGURE LOG

Figure 1 – Parcel map, Book 808, Page 18, Lot 22; Office of County Assessor, Santa Clara County, California; Ranch Site, Christmas Hill Park, Gilroy, CA, effective roll year 2015-2016.

Figure 2 – Plan View of Miller Red Barn; executed by Stuart A. Scott, Structural Engineer, June 2014.

Figure 3 – 1875 Survey Map executed for H. Miller by A. T. Hermann. Santa Clara County Archives. Photo taken by Margaret Aron, April 2015

Figure 4 – Aerial photo of Glen Ranch taken 1950. Santa Clara County Archives. Photo of photo taken by Margaret Aron, January, 2015.

Figure 5 –Google Earth map showing location of property in decimal degrees.

United States Department of the Interior
Here
National Park Service

Miller Red Barn
Name of Property
Santa Clara County California
County and State
Name of multiple listing (if applicable)

National Register of Historic Places

Section number _____ Additional Documentation _____ Page 2

Figure 1 – Parcel map, Book 808, Page 18, Lot 22; Office of County Assessor, Santa Clara County, California; Ranch Site, Christmas Hill Park, Gilroy, CA, effective roll year 2015-2016. Location of subject property indicated by star.



United States Department of the Interior
Here
National Park Service

Miller Red Barn

Name of Property
Santa Clara County California

County and State

Name of multiple listing (if applicable)

National Register of Historic Places

Section number Additional Documentation Page 3

Figure 2 – Plan View of Miller Red Barn; executed by Stuart A. Scott, Structural Engineer, June 2014.

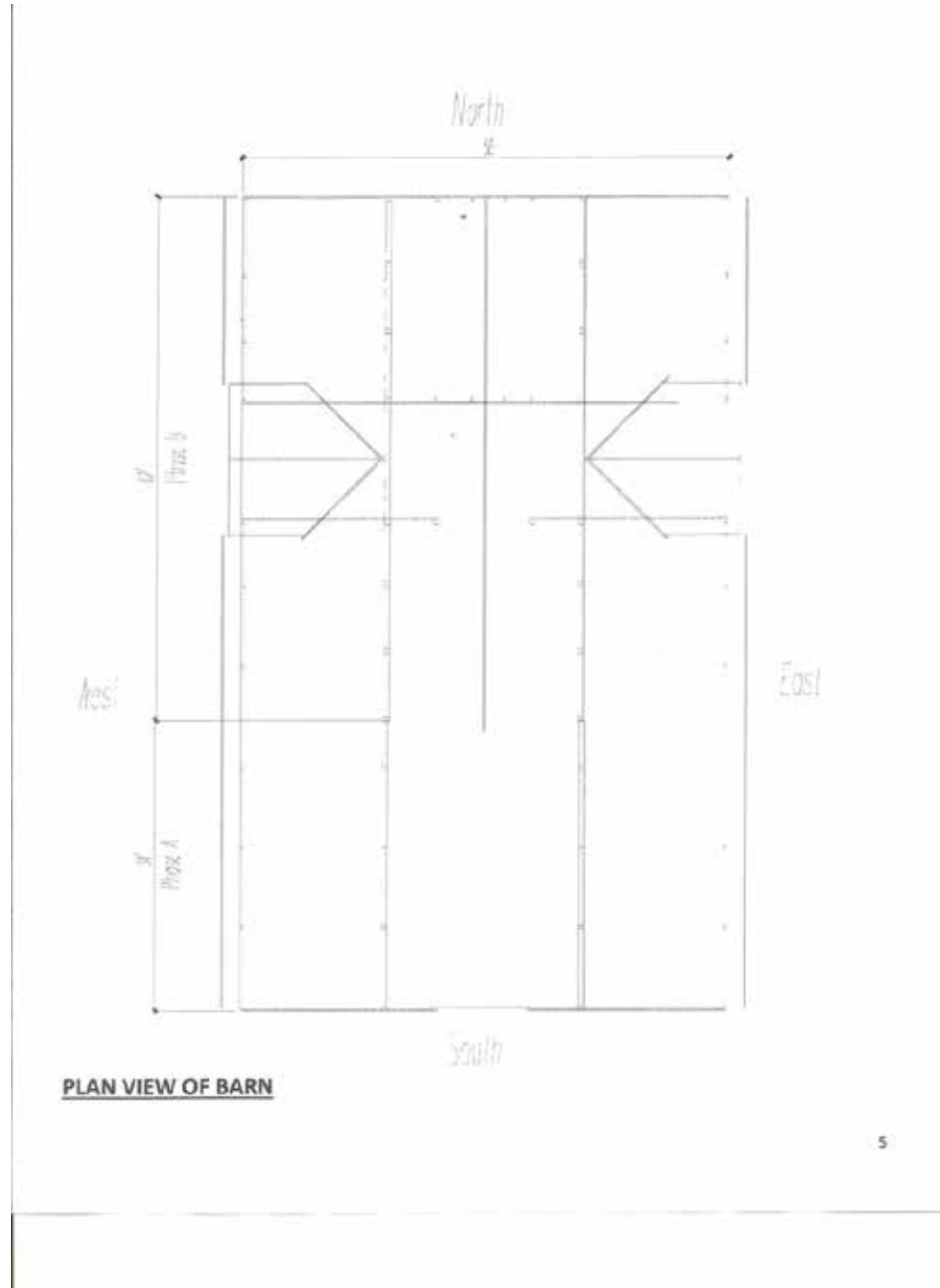

United States Department of the Interior
Here
National Park Service

National Register of Historic Places

Miller Red Barn

Name of Property
Santa Clara County California

County and State

Name of multiple listing (if applicable)

Section number _____ Additional Documentation _____ Page 4

Figure 3 – 1875 Survey Map executed for H. Miller by A. T. Hermann. Santa Clara County Archives.
Photo taken by Margaret Aron, April 2015. Location of property indicated by star.



United States Department of the Interior
Here
National Park Service

Miller Red Barn

Name of Property

Santa Clara County California

County and State

Name of multiple listing (if applicable)

National Register of Historic Places

Section number Additional Documentation

Page 5

Figure 4 – Aerial photo of Glen Ranch taken 1950. Santa Clara County Archives. Photo of photo taken by Margaret Aron, January, 2015. Barn is located below arrow.

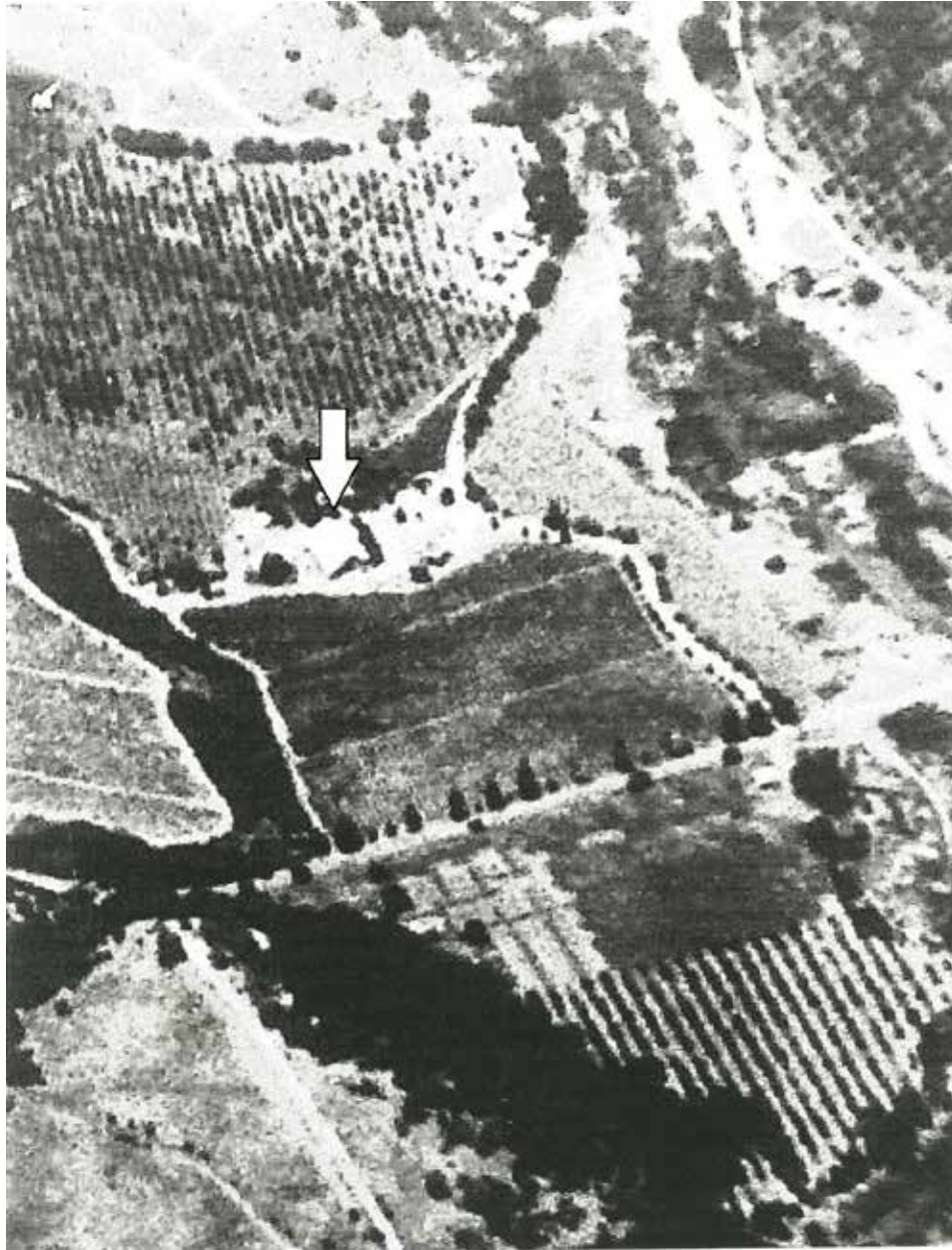

Figure 004 of 4 CA, SantaClara - Miller Red Barn_004
Aerial Photo of Glen Ranch taken 1950 Santa Clara County Archives
1950

United States Department of the Interior
Here
National Park Service

National Register of Historic Places

Miller Red Barn

Name of Property
Santa Clara County California

County and State

Name of multiple listing (if applicable)

Section number _____ Additional Documentation _____ Page 6

Figure 5: Google Earth location map of property.



Latitude: 36.998267

Longitude:-121.588334

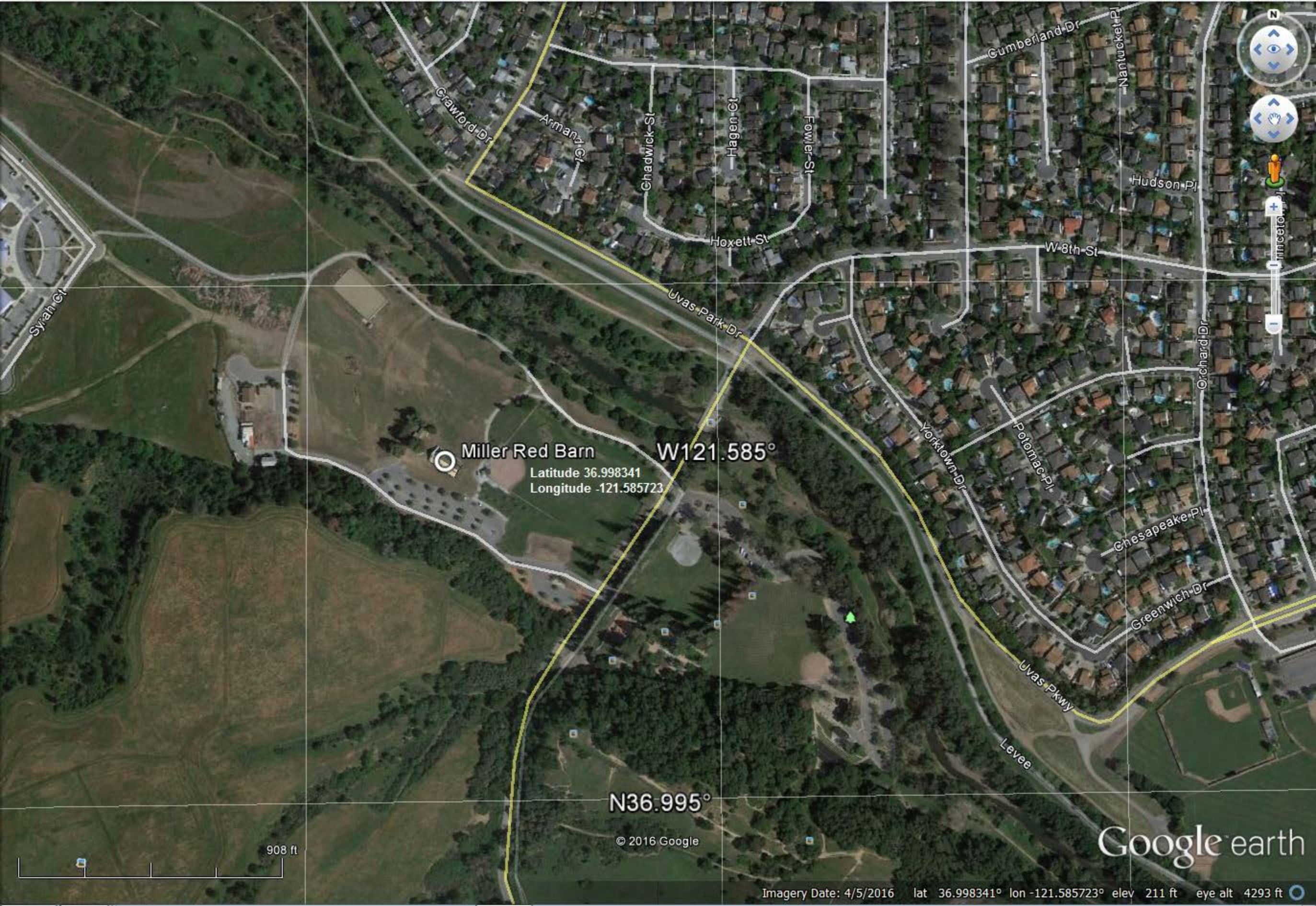

Miller Red Barn
Latitude 36.998341
Longitude -121.585723

W121.585°

N36.995°

© 2016 Google



Google earth



06.24.2015









08.17.2015





Paris & craft

MISC.
SIGNS





National Register of Historic Places
Memo to File

Correspondence

The Correspondence consists of communications from (and possibly to) the nominating authority, notes from the staff of the National Register of Historic Places, and/or other material the National Register of Historic Places received associated with the property.

Correspondence may also include information from other sources, drafts of the nomination, letters of support or objection, memorandums, and ephemera which document the efforts to recognize the property.

UNITED STATES DEPARTMENT OF THE INTERIOR
NATIONAL PARK SERVICE

NATIONAL REGISTER OF HISTORIC PLACES
EVALUATION/RETURN SHEET

REQUESTED ACTION: NOMINATION

PROPERTY NAME: Miller Red Barn

MULTIPLE NAME:

STATE & COUNTY: CALIFORNIA, Santa Clara

DATE RECEIVED: 8/12/16 DATE OF PENDING LIST: 9/02/16
DATE OF 16TH DAY: 9/19/16 DATE OF 45TH DAY: 9/27/16
DATE OF WEEKLY LIST:

REFERENCE NUMBER: 16000665

REASONS FOR REVIEW:

APPEAL: N DATA PROBLEM: N LANDSCAPE: N LESS THAN 50 YEARS: N
OTHER: N PDIL: N PERIOD: N PROGRAM UNAPPROVED: N
REQUEST: N SAMPLE: N SLR DRAFT: N NATIONAL: N

COMMENT WAIVER: N

ACCEPT RETURN REJECT 9.26.16 DATE

ABSTRACT/SUMMARY COMMENTS:

Entered in
The National Register
of
Historic Places

RECOM./CRITERIA _____

REVIEWER _____ DISCIPLINE _____

TELEPHONE _____ DATE _____

DOCUMENTATION see attached comments Y/N see attached SLR Y/N

If a nomination is returned to the nominating authority, the nomination is no longer under consideration by the NPS.

California State Parks
State Office of Historic Preservation
Julianne Polanco, State Historic Preservation Officer
1725 23rd Street, Suite 100
Sacramento, Ca. 95816

Gary Walton
PO Box 1265
Morgan Hill, Ca. 95038
408-857-0162
gary@custom-1.com

June 20, 2016

Dear Madam,

I, Gary Walton support the nomination and preservation of the Miller Red Barn located at 7049 Miller Avenue, Gilroy due to its significant association with the property commonly known as the "Glen Ranch" and its original use as storage for stone fruit that was introduced into Santa Clara County around the time the barn was constructed. The Miller Red Barn has been located in this exact spot since 1891.

Before the advent of "silicon valley", Santa Clara Valley was known as the "Valley of the Hearts Delight" and its wealth was based on the bounty of the land, which it was well known for. Although most of the orchards and farms are gone, this barn has remained as a testament to our regions and our community's agricultural history.

The original barn, which is mostly unaltered, was built specifically to house both crops and workers. It is an unusual barn in that regard for its multi-use capabilities, showcasing the ingenuity and efficiency of the previous generations and specifically its owner, Henry Miller.

We are fortunate that the City purchased the Glen Ranch in order to preserve the open space as part of the city park lands. This barn should remain in its unique and picturesque setting. It would be hard to envision the property without its presence.

The Miller Red Barn is very deserving of its proposed historic designation being considered.

Sincerely,

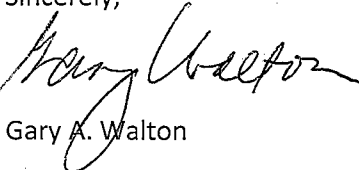

Gary A. Walton

Miller Red Barn
Santa Clara County, California
National Register of Historic Places

The Miller Red Barn is a pole-constructed wooden hay barn built in 1891 in Gilroy, California. It was originally built for California cattle baron Henry Miller. The building is classified as a Western style barn, with wooden frame and siding, front gabled, with a monitor roof. The roof is corrugated sheet metal, which replaced an earlier shingle roof in the 1950s. The building is significant for its association with agriculture in Santa Clara County through several differing but related agricultural uses.

The construction of the barn was apparently done in two phases, according to a 2014 structural evaluation. The first phase was the southern 35 feet of the barn, while the second phase covers the northern 61 feet. The barn is board-and-batten redwood siding. Wall dormers are located on the eastern and western walls in the middle of the second phase of the building, with double doors beneath the eastern dormer's gable. An opening for the entrance beneath the western dormer is enclosed in a wall of redwood. The interior of the barn is separated into a central corridor between the wall dormers, an enclosed area on the building's north end, and a large open space to the south closest to the southern entrance to the building. Large open trusses support the main and monitor roofs, allowing natural light to enter the barn via the monitor windows. The building retains a high degree of historic integrity in all aspects other than replacement of the original shingle roof with corrugated metal.

The building is eligible under Criterion A for its role in agriculture, with a period of significance from 1891, the year of the barn's construction, to 1941, the year of the sale of the Glen Farm Ranch from the Henry Miller estate. The building was constructed as a hay barn for Henry Miller, partner in the San Francisco cattle raising and meat packing partnership of Miller and Lux, as part of the Glen Farm ranch. Transition from cattle ranching to fruit orchards on the Glen Farm in the 1890s led to a change in role for the barn, used for storage and packing of fresh and dried fruit. The barn was also modified for use as temporary lodging for seasonal workers. In 1906, the Glen Farm was leased to the California Wine Association and production shifted from tree fruit to wine grape growing. The barn was then utilized for viticulture. The lease ended 15 years later, with the beginning of Prohibition in California, but its use restarted in 1933 by the family of Bruno Filice, who purchased the defunct California Wine Company and renamed it the San Martin Winery. In 1941, the Glen Farm and the barn were purchased by the San Martin Winery, who continued its use under new ownership, but association with the Miller family had ended.

The nomination was submitted by a third party. The property owner, the City of Gilroy, has not commented on this nomination. Eleven letters of support have been received.

Staff supports the nomination as written and recommends that the State Historical Resources Commission support the determination that the Miller Red Barn is eligible under Criterion A at the local level of significance, with a period of significance of 1891-1941, and should be listed in the National Register. Staff recommends the State Historic Preservation Officer approve the nomination for forwarding to the National Park Service for listing in the National Register of Historic Places.

William Burg
State Historian II
June 30, 2016

Dear Sir:

An application for Miller Red Barn in Gilroy, Ca. is to be reviewed by The National Register of Historic Places Commission on July 29th.

I am writing in favor of the approval of the Commission. This barn was built by Henry Miller in 1891. There is hardly anything left of Mr. Miller's vast holdings and of his power and influence in California's rich history. The City had an ordinance to tear down this barn and the history behind it. A small group of concerned citizens have succeeded in getting this order reversed, but it needs all of our continued efforts to save it.

I ask that the Commission review this application favorably so the barn can be saved and that this authentic link to the past be protected.

Sincerely,

Gloria Caliri

California State Parks
State Office of Historic Preservation
Julianne Polanco, State Historic Preservation Officer
1725 23rd Street, Suite 100
Sacramento, Ca. 95816

Gary Walton
PO Box 1265
Morgan Hill, Ca. 95038
408-857-0162
gary@custom-1.com

June 20, 2016

Dear Madam,

I, Gary Walton support the nomination and preservation of the Miller Red Barn located at 7049 Miller Avenue, Gilroy due to its significant association with the property commonly known as the "Glen Ranch" and its original use as storage for stone fruit that was introduced into Santa Clara County around the time the barn was constructed. The Miller Red Barn has been located in this exact spot since 1891.

Before the advent of "silicon valley", Santa Clara Valley was known as the "Valley of the Hearts Delight" and its wealth was based on the bounty of the land, which it was well known for. Although most of the orchards and farms are gone, this barn has remained as a testament to our regions and our community's agricultural history.

The original barn, which is mostly unaltered, was built specifically to house both crops and workers. It is an unusual barn in that regard for its multi-use capabilities, showcasing the ingenuity and efficiency of the previous generations and specifically its owner, Henry Miller.

We are fortunate that the City purchased the Glen Ranch in order to preserve the open space as part of the city park lands. This barn should remain in its unique and picturesque setting. It would be hard to envision the property without its presence.

The Miller Red Barn is very deserving of its proposed historic designation being considered.

Sincerely,

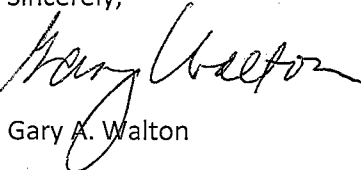

Gary A. Walton

Dear Sir,

I'm writing in favor of approval of the current application for listing the historic Henry Miller Barn, Gilroy, CA. The iconic old barn fits the State's criteria, and without public recognition is in real jeopardy of being destroyed by the City of Gilroy. In fact it would be gone by now, except for the stubborn efforts of citizens, once the demolition order was published in the City Council Minutes.

There is hardly anything tangible left of Henry Miller's vast empire that stretched across California & into Oregon & Washington. He ranks just below the big 4 in wealth, power, & influence in California's history. Yet few people know his name today, or his innovative leadership in agriculture and water management.

This structure has survived almost 125 years, unmodified. Miller had a very large regional ranch headquarters/village, family mansion and summer homes nearby, but they are gone – only a few foundations & silos remain. Originally built in 1891, right after the devastating drought of 1889-1890, this redwood barn was used for dried fruit processing. The building is a testament to south Santa Clara County's nickname "the Valley of Heart's Delight" & the area was famous as the best place to grow stoned fruits in the world. In the early 1900s the barn was leased by early grape wine vintners. Agriculture dominated life in southern Santa Clara County & the adjacent counties until recently when commuters to Silicon Valley have replaced farms with tract homes. This barn remains an authentic link to the past and should be protected.

Thank you for reading my letter.

Sincerely, Maureen Hunter

RECEIVED

JUL 15 2016

OHP

Patricia Baldwin Escamilla
P. O. Box 906
Klamath Falls, OR 97601
541-850-3236

July 10, 2016

California Office of Historic Preservation
State Historical Resources Commission
P. O. Box 942896
Sacramento, California 94296-0001

Letter in Support of National Register Nomination of Miller Red Barn in Santa Clara County

Dear Commissioners:

As the foremost scholar on Henry Miller, known as the Cattle King, and author of his definitive biography, *Beyond the Cattle King, The Life and Times of Henry Miller*, I have been asked to submit a letter of support for the National Register Nomination of the Miller Red Barn, near Gilroy, in south Santa Clara County. The hay barn, originally 35' x 56', was adapted to fruit storage and processing in 1891 by Henry Miller who was interested in all phases of agriculture, beyond his extensive livestock ranching and processing business. The redwood posts, beams, lumber, and shingles used in the barn were milled at Miller's Mt. Madonna property. Knowing Mr. Miller as I do, I think he would only have used the most capable and reputable workmen of his day on the construction of this barn. As was stated in the nomination, if Henry Miller walked into the barn today, 125 years later, he would instantly recognize the building as that which he had built in 1891.

Of note, beyond the very accurate information given in the nomination, is the fact that all of Henry Miller's homes and business locations in San Francisco, prior to the 1906 earthquake, were destroyed by the fire that followed. The home Miller built in 1907 at 2101 Laguna Street in San Francisco was replaced by a large apartment building in the 1960s. His home at Bloomfield Farm, built in 1888, was also destroyed by a fire in 1923. All the structures on the Miller Home Site at his summer property on Mt. Madonna, now a county park west of Gilroy, were dismantled and removed for other uses in 1933.

The loss of the historic sites associated with Henry Miller, one of the men who shaped not only California but the young West, and was truly the Father of California Agribusiness, makes the preservation of the Miller Red Barn of vital importance to our agricultural history as well as our history in general, and to the understanding future generations will have of that history. I hope you will recognize the historic value of the Miller Red Barn and assist in its preservation by placing the structure on the National Register of Historic Places.

Sincerely,

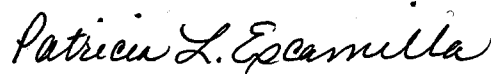

Patricia Baldwin Escamilla

Dear Sir:

An application for Miller Red Barn in Gilroy, Ca. is to be reviewed by The National Register of Historic Places Commission on July 29th.

I am writing in favor of the approval of the Commission. This barn was built by Henry Miller in 1891. There is hardly anything left of Mr. Miller's vast holdings and of his power and influence in California's rich history. The City had an ordinance to tear down this barn and the history behind it. A small group of concerned citizens have succeeded in getting this order reversed, but it needs all of our continued efforts to save it.

I ask that the Commission review this application favorably so the barn can be saved and that this authentic link to the past be protected.

Sincerely,

Gloria Caliri

From: [Philip Bowles](#)
To: [Burg, William@Parks](mailto:Burg.William@Parks)
Cc: [Carol A. DeSantis](#); [Peter Lombardi](#)
Subject: Gilroy: Christmas Hill Park Red Barn
Date: Tuesday, July 19, 2016 2:31:46 PM

Dear Mr. Burg:

I am writing in support of the effort to get the subject property listed in the National Register of Historic Places, and to request the State's assistance in this matter. The formal application goes into great detail about the history and nature of the structure, so I won't repeat that information here. What matters to me is that this building is a relic of a largely vanished place, Old Gilroy if you will, a thriving town of agriculturalists and small merchants at the turn of the 19th century. Most of what is Gilroy today is pleasant enough, but it has become generic Suburbia, comparable to tens of thousands of similar towns across our country. A building like the Red Barn reminds people of their past, and informs children and newcomers about a world that is becoming lost to them.

Most importantly, it stands in a well-used public park in central Gilroy, not in some obscure and hard-to-reach location like so many historically important but underused buildings.

This will not be an expensive building to repair and maintain, nor will its listing (being already on public land) affect the local tax rolls. Properly restored, the Red Barn can be used for a variety of public purposes, including storytelling, dances, weddings, folk music concerts, and family gatherings.

Thank you for your consideration of my opinion.

Sincerely,

Philip E. Bowles
3323 Washington St.
San Francisco, CA 94118
(415) 421-4800

From: [Beatrice Bowles](#)
To: [Burg, William@Parks](mailto:Burg.William@Parks)
Subject: Gilroy's Red Barn
Date: Tuesday, July 19, 2016 5:01:28 PM

Dear Mr. Burg:

I favor the effort to get the Red Barn listed in the National Register of Historic Places, and to request the State's assistance in this matter. The formal application details the history of the structure, so I won't repeat all that here. What matters to me is that this building is a relic of a largely vanished place, Old Gilroy if you will, a thriving town of agriculturalists and small merchants at the turn of the 19th century. Most of what is Gilroy today is pleasant enough, but it has become generic Suburbia, comparable to tens of thousands of similar towns across our country. A building like the Red Barn reminds people of their past, and informs young and old about a world that is becoming lost to them.

Most importantly, it stands in a well-used public park in central Gilroy, not in some obscure location like so many historically important and underused buildings.

This will not be an expensive repair project, nor will its listing (being already on public land) affect the local tax rolls. Properly restored, the Red Barn can be used for a variety of public purposes, including history education, storytelling, cultural affairs, weddings, concerts, reunions, and family gatherings.

Thank you for your consideration of my opinion.

Sincerely,

Bearice Bowles

Letter from Ms. deSantis follows:

From: richard.perino
To: Burg.William@Parks
Subject: Henry Miller Red Barn, Gilroy, CA
Date: Saturday, July 16, 2016 12:20:11 PM

Dear Sir:

Please understand that I am in favor of Saving the Miller Red Christmas Hill Park in Gilroy. It is the last remaining building built by Henry Miller. At time Henry Miller used Gilroy as his home base having a four story Home and a summer home on the Hecker Pass. The Gilroy City Council voted to have the Barn turn down and replaced will an open field. The Miller Red Barn Assocation Was able to get the City to reverse the demoltion order.

The Barn has survived for over 125 years, Originally built in 1891, We need to save this barn to be used a Museum horoning the agriculture hетиage of the area, Starting with the Indians to todays agriculture in the 21st century. The area around Gilroy is growing very fast most of the agricuktural lans are gving way to homes. As an link to the past we need to save the Barn for future generations to learn about the pasts agricultural beginnings of the area.

Richard Perino riccip2@msn.com

From: [Lawrence John Mark](#)
To: [Burg, William@Parks](#)
Subject: HM Red Barn in Gilroy
Date: Tuesday, July 19, 2016 7:25:27 PM

Parks Department of the State of California,

I hope the barn can be saved. It can be a wonderful facility for the enjoyment of people in a special setting that reminds and brings to mind our history, short as it sure is. And, Henry Miller's descendants are proud to see recognition of his many achievements that have had such a real effect on us all.

John Mark Lawrence

From: [Phill Laursen](#)
To: Burg.William@Parks
Subject: Re: Miller Red Barn
Date: Saturday, July 16, 2016 11:32:14 PM

I most enthusiastically recommend a positive review of the application for the Miller Red Barn of Gilroy to be listed on the National Register of Historic Places.

I've been involved for about 15 years in the Gilroy Historical Society. Years ago I was intrigued by suggestions the old red barn in Gilroy's Christmas Hill Park was built by Henry Miller. I asked the current head of the Filice Family that owned the former Glen Ranch, wherein the barn is located, but he had no record of the barn's history. I asked the daughter of a former foreman of the Glen Ranch; now in her 90s, she said the barn was very old when her Dad worked there in the 1930's. I asked the City's Parks and Recreation Supervisor (now deceased) and he had no records either.

Fast forward a few years and a great group grew up to save what we now know is the Miller Red barn from demolition. Searching for evidence of Henry Miller's ownership, raising awareness and funds for support, the group was able to convince the City Council of the barn's provenance and its importance for the community. I'm proud to have been a part of that group, and I look forward to the day when the barn's future is ensured and when the legacy of Henry Miller is celebrated as an important part of Gilroy's heritage.

A positive review by the California State Historic Resources Commission will not only support the appreciation of a vital chapter in California's history, it will help create an icon of the rich culture of a city built on agriculture.

Sincerely,

Phill Laursen

**OFFICE OF HISTORIC PRESERVATION
DEPARTMENT OF PARKS AND RECREATION**

1725 23rd Street, Suite 100
SACRAMENTO, CA 95816-7100
(916) 445-7000 Fax: (916) 445-7053
calshpo@parks.ca.gov
www.ohp.parks.ca.gov

**RECEIVED 2280**

AUG 12 2016

**Nat. Register of Historic Places
National Park Service**

August 4, 2016

J. Paul Loether
Deputy Keeper and Chief, National Register and National Historic Landmark Program
National Register of Historic Places
National Park Service 2280
1201 I (Eye) Street, NW, 8th Floor
Washington, DC 20005

Subject: **Miller Red Barn
Gilroy, Santa Clara County County, California
National Register of Historic Places**

Dear Mr. Loether:

The enclosed disk contains the true and correct copy of the nomination for the Miller Red Barn to the National Register of Historic Places. This property is located in Gilroy, Santa Clara County, California. On July 29, 2016, the State Historical Resources Commission unanimously found the property eligible for the National Register under Criterion A at the local level of significance.

The property is nominated by a third party, the Miller Red Barn Committee. The property owner, the city of Gilroy, has not commented on this nomination. Eleven letters of support were received and are included as correspondence on the enclosed disk.

If you have any questions regarding this nomination, please contact William Burg of my staff at 916-445-7004.

Sincerely,

A handwritten signature in blue ink, appearing to read "Julianne Polanco".

hp
Julianne Polanco
State Historic Preservation Officer

Enclosures