

PH0005606

MHT CH-5

Form 10-300
(July 1969)

UNITED STATES DEPARTMENT OF THE INTERIOR
NATIONAL PARK SERVICE

NATIONAL REGISTER OF HISTORIC PLACES
INVENTORY - NOMINATION FORM

(Type all entries - complete applicable sections)

STATE:	Maryland	
COUNTY:	Charles	
FOR NPS USE ONLY		
ENTRY NUMBER	DATE	
	OCT 31 1972	

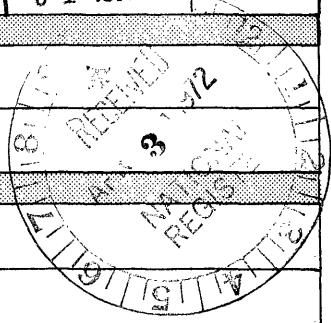

1. NAME

COMMON: Habre de Venture

AND/OR HISTORIC: Habre-de-Venture, Habredeventure

2. LOCATION

STREET AND NUMBER: Rose Hill Road

CITY OR TOWN: Port Tobacco

STATE	CODE	COUNTY:	CODE
Maryland	24	Charles	017

3. CLASSIFICATION

CATEGORY (Check One)	OWNERSHIP	STATUS	ACCESSIBLE TO THE PUBLIC
<input type="checkbox"/> District <input type="checkbox"/> Site <input type="checkbox"/> Object	<input checked="" type="checkbox"/> Building <input type="checkbox"/> Structure <input type="checkbox"/> Private <input type="checkbox"/> Both	<input type="checkbox"/> Public <input type="checkbox"/> In Process <input type="checkbox"/> Being Considered	<input checked="" type="checkbox"/> Occupied <input type="checkbox"/> Unoccupied <input type="checkbox"/> Preservation work in progress
PRESENT USE (Check One or More as Appropriate)			
<input checked="" type="checkbox"/> Agricultural <input type="checkbox"/> Commercial <input type="checkbox"/> Educational <input type="checkbox"/> Entertainment	<input type="checkbox"/> Government <input type="checkbox"/> Industrial <input type="checkbox"/> Military <input type="checkbox"/> Museum	<input type="checkbox"/> Park <input checked="" type="checkbox"/> Private Residence <input type="checkbox"/> Religious <input type="checkbox"/> Scientific	<input type="checkbox"/> Transportation <input type="checkbox"/> Other (Specify)

4. OWNER OF PROPERTY

OWNER'S NAME: Mrs. Peter Vischer

STREET AND NUMBER: Rose Hill Road

CITY OR TOWN: Port Tobacco

STATE:	CODE
Maryland	24

5. LOCATION OF LEGAL DESCRIPTION

COURTHOUSE, REGISTRY OF DEEDS, ETC.: Hall of Records

STREET AND NUMBER: St. John's College Campus, College Avenue

CITY OR TOWN: Annapolis

STATE	CODE
Maryland	24

6. REPRESENTATION IN EXISTING SURVEYS

TITLE OF SURVEY: SEE CONTINUATION SHEET
Maryland Register of Historic Sites and Landmarks

DATE OF SURVEY: 1968 Federal State County Local

DEPOSITORY FOR SURVEY RECORDS: Maryland Historical Trust

STREET AND NUMBER: 94 College Avenue

CITY OR TOWN: Annapolis

STATE:	CODE
Maryland	24

SEE INSTRUCTIONS

STATE: Maryland

COUNTY: Charles

ENTRY NUMBER: OCT 31 1972

FOR NPS USE ONLY

DATE:

7. DESCRIPTION

CONDITION

(Check One)					
<input checked="" type="checkbox"/> Excellent	<input type="checkbox"/> Good	<input type="checkbox"/> Fair	<input type="checkbox"/> Deteriorated	<input type="checkbox"/> Ruins	<input type="checkbox"/> Unexposed
(Check One)			(Check One)		
<input type="checkbox"/> Altered	<input checked="" type="checkbox"/> Unaltered	<input type="checkbox"/> Moved	<input checked="" type="checkbox"/> Original Site		

DESCRIBE THE PRESENT AND ORIGINAL (if known) PHYSICAL APPEARANCE

Habre de Venture is located on the west side of Rose Hill Road, north of "Rose Hill," south of the intersection of Rose Hill Road, Bumpy Oak Road, Marshalls Corner Road and Maryland Route 225, about three miles west of La Plata, Maryland.

Habre de Venture is an irregular five-part Maryland manor-style house composed of three different early building methods and arranged in an arc. The central section is a brick, one-and-one-half story house with a gambrel roof. There are five bays in the north elevation including one which is a door; and one of the five bays of the south elevation is a door.

There are three dormers in the lower portion of the gambrel roof just above an overhanging porch, or porte cochere, on the entrance (north) side which is supported by six plain, square columns. There is a raised, screened porch of **twentieth-century** vintage on the south facade. This main section is raised on a brick base. The porch roofs as well as the other roofs are wood shingle. The hyphen to the north-west is a section of the house in its own right but smaller, with an elevated gambrel roof. This brick section is three bays long with two dormers. The brick is Flemish bond with glazed headers.

The hyphen connects a small, two-story frame wing, set perpendicular to the hyphen; this wing has brick end walls with an internal chimney at the north and south ends. To the east of the central section is a small, completely frame, one-and-one-half story, gambrel roof structure with no dormers, that served as Thomas Stone's law office. It has an external chimney at the southeast end and the framing is visible on the interior.

The living room paneling from the main section of the house is now in the Baltimore Museum of Art, Baltimore, Maryland, but other early paneling and woodwork remains.

The paneling in the museum continues to have its original, and early, coat of paint. The paneling now in the house was reconstructed and installed during the Vischer restoration in 1945.

The 1972 owner restored the house and also built a polygonal, brick toolhouse for the garden needs as well as a gambrel roof garage.

Habre de Venture is a working farm where thoroughbred horses are bred and raised.

SEE CONTINUATION SHEET

SEE INSTRUCTIONS

**NATIONAL REGISTER OF HISTORIC PLACES
INVENTORY - NOMINATION FORM**

(Continuation Sheet)

STATE	
Maryland	
COUNTY	
Charles	
FOR NPS USE ONLY	
ENTRY NUMBER	DATE
OCT 31 1972	

(Number all entries)

Habre de Venture

#6. REPRESENTATION IN EXISTING SURVEYS continued

Historic American Building Survey

Federal 1969

Library of Congress
Washington, D. C. Code: 11

#7. DESCRIPTION continued

The square on the map comprising two hundred and fifty-six acres is designated because the property served as the home of a signer of the Declaration of Independence and the acreage is needed to interpret the rural setting of that period.

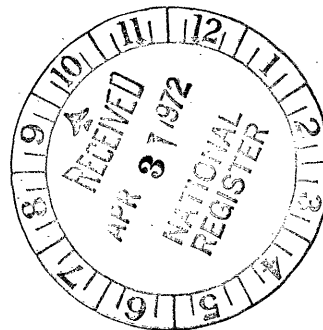

SIGNIFICANCE

PERIOD (Check One or More as Appropriate)

- Pre-Columbian | 16th Century | 18th Century | 20th Century
 15th Century | 17th Century | 19th Century

SPECIFIC DATE(S) (If Applicable and Known)

c. 1775

AREAS OF SIGNIFICANCE (Check One or More as Appropriate)

- | | | | |
|--|---|---|--|
| <input type="checkbox"/> Aboriginal | <input type="checkbox"/> Education | <input checked="" type="checkbox"/> Political | <input type="checkbox"/> Urban Planning |
| <input type="checkbox"/> Prehistoric | <input type="checkbox"/> Engineering | <input type="checkbox"/> Religion/Philosophy | <input type="checkbox"/> Other (Specify) |
| <input type="checkbox"/> Historic | <input type="checkbox"/> Industry | <input type="checkbox"/> Science | |
| <input type="checkbox"/> Agriculture | <input type="checkbox"/> Invention | <input type="checkbox"/> Sculpture | |
| <input checked="" type="checkbox"/> Architecture | <input type="checkbox"/> Landscape Architecture | <input type="checkbox"/> Social/Humanitarian | |
| <input type="checkbox"/> Art | <input type="checkbox"/> Literature | <input type="checkbox"/> Theater | |
| <input type="checkbox"/> Commerce | <input type="checkbox"/> Military | <input type="checkbox"/> Transportation | |
| <input type="checkbox"/> Communications | <input type="checkbox"/> Music | | |
| <input type="checkbox"/> Conservation | | | |

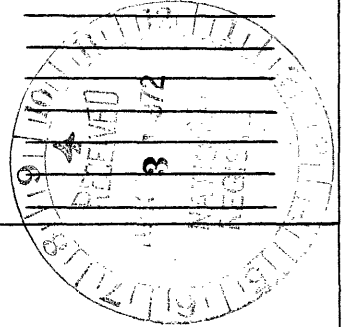

STATEMENT OF SIGNIFICANCE

ARCHITECTURAL SIGNIFICANCE

Habre de Venture has an unusual floor plan. Henry Chandlee Forman called the plan unique in his Early Manor and Plantation Houses of Maryland. The architectural quality of the house is attested to by the fact that the living room paneling is in the exhibit of room interiors in the Baltimore Museum of Art, Baltimore, Maryland. Although rehabilitated, Habre de Venture retains much of its early character.

HISTORICAL SIGNIFICANCE

Thomas Stone (1743-1787), a Signer of the Declaration of Independence, built Habre de Venture after 1771 and lived there for the remainder of his life. A native of Nanjemoy Hundred, Charles County, he had moved to Annapolis to study law under Maryland's first elected governor (1777-1779), Thomas Johnson (1732-1819). In 1764 Stone was admitted to the Maryland Bar after which he moved to Frederick as did Thomas Johnson, John Hanson and Francis Scott Key.

Stone chose a Charles County bride, Margaret Brown, daughter of Dr. Gustavus Richard Brown (1747-1804), a physician to George Washington. Stone abandoned Frederick after the death of his father, Daniel Stone, returning to his native Charles County. Within a month afterwards, Thomas, his mother Elizabeth Jenifer Stone, and his younger brother John Hoskins Stone (1745-1804) (Governor of Maryland 1794-1797) filed the inventory of Daniel Stone's estate. Thomas Stone had purchased 442 acres from Daniel Jenifer, the nucleus of Stone's estate.

After re-establishing himself in Charles County, Stone entered Maryland politics and, later, national politics. In the 1770's Marylanders were beginning to question the legality of the royal authority imposed without the consent of the governed. Bostonians threw British tea into the harbor while Marylanders, in 1774, tested the legality of the British

SEE CONTINUATION SHEET

SEE INSTRUCTIONS

9. MAJOR BIBLIOGRAPHICAL REFERENCES

Recorders:

William D. Morgan, Maryland Historical Trust, 94 College Avenue, Annapolis, Maryland 21401.

Nancy Miller, Historian, Maryland Historical Trust.

J. Richard Rivoire, Maryland Historical Trust.

SEE CONTINUATION SHEET

10. GEOGRAPHICAL DATA

LATITUDE AND LONGITUDE COORDINATES DEFINING A RECTANGLE LOCATING THE PROPERTY			O R	LATITUDE AND LONGITUDE COORDINATES DEFINING THE CENTER POINT OF A PROPERTY OF LESS THAN TEN ACRES		
CORNER	LATITUDE	LONGITUDE		LATITUDE	LONGITUDE	
	Degrees Minutes Seconds	Degrees Minutes Seconds		Degrees	Minutes	Seconds
NW	38° 32' 08"	77° 02' 43"		°	'	"
NE	38° 32' 08"	77° 02' 03"		°	'	"
SE	38° 31' 36"	77° 02' 03"		°	'	"
SW	38° 31' 36"	77° 02' 43"		°	'	"

APPROXIMATE ACREAGE OF NOMINATED PROPERTY: **256 acres**

LIST ALL STATES AND COUNTIES FOR PROPERTIES OVERLAPPING STATE OR COUNTY BOUNDARIES

STATE:	CODE	COUNTY	CODE

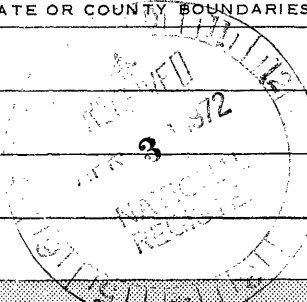

SEE INSTRUCTIONS

11. FORM PREPARED BY

NAME AND TITLE:
Mrs. Preston Parish, Keeper of the Maryland Register

ORGANIZATION: **Maryland Historical Trust** DATE: **February 2, 1972**

STREET AND NUMBER:
94 College Avenue

CITY OR TOWN: **Annapolis** STATE: **Maryland** CODE: **24**

12. STATE LIAISON OFFICER CERTIFICATION NATIONAL REGISTER VERIFICATION

<p>As the designated State Liaison Officer for the National Historic Preservation Act of 1966 (Public Law 89-665), I hereby nominate this property for inclusion in the National Register and certify that it has been evaluated according to the criteria and procedures set forth by the National Park Service. The recommended level of significance of this nomination is:</p> <p>National <input checked="" type="checkbox"/> State <input type="checkbox"/> Local <input type="checkbox"/></p> <p>Name <u>Orlando Ridout IV</u> Orlando Ridout IV</p> <p>Title <u>State Liaison Officer for Maryland</u></p> <p>Date <u>February 3, 1972</u></p>	<p>I hereby certify that this property is included in the National Register.</p> <p><u>Robert Van Ueley</u> Chief, Office of Archeology and Historic Preservation</p> <p>Date <u>10/31/72</u></p> <p>ATTES: <u>William H. Hunt</u> Keeper of The National Register</p> <p>Date <u>10-30-72</u></p>
--	--

Form 10-300a
(July 1969)UNITED STATES DEPARTMENT OF THE INTERIOR
NATIONAL PARK SERVICENATIONAL REGISTER OF HISTORIC PLACES
INVENTORY - NOMINATION FORM

(Continuation Sheet)

STATE	
Maryland	
COUNTY	
Charles	
FOR NPS USE ONLY	
ENTRY NUMBER	DATE
OCT 3 1972	

(Number all entries)

Habre de Venture

#8. SIGNIFICANCE continued

poll tax. Thomas Stone, a loyal British subject, defended the tax in court. Thomas Johnson, William Paca and Samuel Chase were among those who opposed it.

Within a year, by 1775, Stone became affected by the contagious germ of revolutionary forces. On July 8, 1775, he, as a Maryland delegate to the Continental Congress, signed its petition of protest addressed to George III. Still unsure of the appropriate reaction to "taxation without representation" Stone, in April of 1776, still hoped that reconciliation with England was possible. However, having said "...war, anything is preferable to a surrender of our rights," he finally reached the decision to declare himself for separation from England through putting his signature on the Declaration of Independence.

Thomas Stone, a great-grandson of William Stone, a seventeenth-century Maryland Provincial Governor, continued to serve his state and country as State Senator and as a Delegate to the Congress under the Articles of Confederation. In 1784 Congress chose him for Chairman, a position he held for a few days. In 1787 he was chosen as a delegate to the Constitutional Convention, a position he declined. On October 5, 1787, while waiting to depart on an ocean voyage to improve his failing health, Stone died. From that time until 1945 Habre de Venture remained in the hands of Thomas Stone's descendants.

Michael Stone, early twentieth-century owner, sold the "Great Room" paneling to the City of Baltimore which gave it, in 1928, to the Baltimore Museum of Art.

In 1945 Mr. Peter Vischer, a New York newspaper man and magazine publisher, and his wife, an author using the pseudonym, Helen Lombard, as well as being a journalist, purchased Habre de Venture, restored the house and established a stable in which to breed thoroughbred horses. The Vischer "Burgundy and White" stable colors were seen at the Laurel, Bowie and Pimlico race tracks before Mr. Vischer's death. Mrs. Vischer has continued to hold a license to race in Maryland (1970).

Form 10-300a
(July 1969)UNITED STATES DEPARTMENT OF THE INTERIOR
NATIONAL PARK SERVICENATIONAL REGISTER OF HISTORIC PLACES
INVENTORY - NOMINATION FORM

(Continuation Sheet)

STATE	
Maryland	
COUNTY	
Charles	
FOR NPS USE ONLY:	
ENTRY NUMBER	DATE
001 3 1	1972

(Number all entries)

Habre de Venture

#9. REFERENCES continued

Delaplaine, Edward S. The Life of Thomas Johnson, New York: Grafton Press, 1927.

Hinkel, John V. et al (compiler), Charles County Founded in 1658, [Washington: n.p.], 1959.

Klaphor, Margaret Brown, and Paul Dennis Brown, The History of Charles County, Maryland, Written in Its Tercentenary Year of 1958, La Plata, Md.: Charles County Tercentenary, Inc., [1958?].

"Charles Countians Who Have Served in Congress," The Record [Charles County Historical Society], (December 1965), 1-4.

Dictionary of American Biography, 20 vols., New York: Charles Scribner's Sons, 1936, XVII.

The Sun (Baltimore), April 14, 1929; August 19, 1934; July 15, 1963; September 28, 1969.

Scarborough, Katherine, "A Ramble Through Maryland's Gardens A Tour That Will Help Restore Colonial Annapolis," The Sun (Baltimore), April 18, 1937.

Burnett, Edmund C., Letters of Members of the Continental Congress, 8 vols., Washington: Carnegie Institute, 1923, II.

Charles County Inventories, Hall of Records, Annapolis, Maryland.

Baltimore Museum of Art, Baltimore, Maryland. Display of room interiors.

Forman, Henry Chandlee. Early Manor and Plantation Houses of Maryland, Easton, Maryland: 1934, pp 77.

Scarborough, Katherine, Homes of the Cavaliers, New York: MacMillian Company, 1930.

Vischer, Mrs. Peter, Port Tobacco, Maryland. Interview.

◦ KEY ◦

- 1. OFFICE
- 2. CELLAR ENTR.
- 3. LIVING ROOM
- 4. HALL
- 5. LIBRARY
- 6. DINING ROOM
- 7. NEW KITCHEN
- 8. HALL
- 9. OLD KITCHEN
- 10. PORCH
- 11. PORCH
- 12. GARDEN

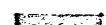
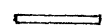
-  BRICK
-  FRAME

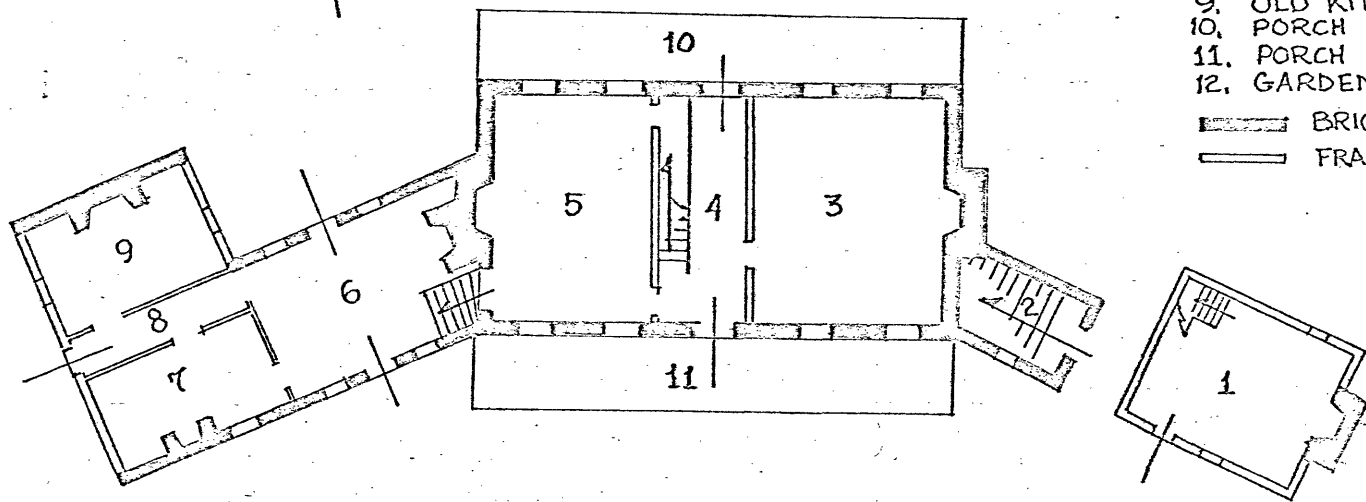

◦ HABRE DE VENTURE ◦

NOT DRAWN TO SCALE

J. R. RIVOIRE 12/71

#7. DESCRIPTION continued

(2 of 4 continuation sheets)