



United States Department of the Interior
National Park Service

National Register of Historic Places Registration Form

This form is for use in nominating or requesting determinations for individual properties and districts. See instructions in National Register Bulletin, *How to Complete the National Register of Historic Places Registration Form*. If any item does not apply to the property being documented, enter "N/A" for "not applicable." For functions, architectural classification, materials, and areas of significance, enter only categories and subcategories from the instructions.

1. Name of Property

Historic name: Standard Paper Box Corporation

Other names/site number: Douglas Young, Inc.

Name of related multiple property listing:
N/A

(Enter "N/A" if property is not part of a multiple property listing)

2. Location

Street & number: 110 Kenyon Avenue

City or town: Pawtucket State: RI County: Providence

Not For Publication: Vicinity:

3. State/Federal Agency Certification

As the designated authority under the National Historic Preservation Act, as amended,

I hereby certify that this X nomination ___ request for determination of eligibility meets the documentation standards for registering properties in the National Register of Historic Places and meets the procedural and professional requirements set forth in 36 CFR Part 60.

In my opinion, the property X meets ___ does not meet the National Register Criteria. I recommend that this property be considered significant at the following level(s) of significance:

___ national x statewide ___ local
Applicable National Register Criteria:

x A ___ B x C ___ D

	<u>1/13/2015</u>
Signature of certifying official/Title:	Date
<u>RI Historical Preservation & Heritage Commission</u>	
State or Federal agency/bureau or Tribal Government	

In my opinion, the property ___ meets ___ does not meet the National Register criteria.	
Signature of commenting official:	Date
Title :	State or Federal agency/bureau or Tribal Government

4. National Park Service Certification

I hereby certify that this property is:

- entered in the National Register
- determined eligible for the National Register
- determined not eligible for the National Register
- removed from the National Register
- other (explain:)

Signature of the Keeper

2/24/2015
Date of Action

5. Classification

Ownership of Property

(Check as many boxes as apply.)

- Private:
- Public – Local
- Public – State
- Public – Federal

Category of Property

(Check only **one** box.)

- Building(s)
- District
- Site
- Structure
- Object

Number of Resources within Property

(Do not include previously listed resources in the count)

Contributing	Noncontributing	
<u>3</u>	<u>1</u>	buildings
_____	_____	sites
_____	_____	structures
_____	_____	objects
<u>3</u>	<u>1</u>	Total

Number of contributing resources previously listed in the National Register N/A

6. Function or Use

Historic Functions

(Enter categories from instructions.)

INDUSTRY/manufacturing facility

Current Functions

(Enter categories from instructions.)

INDUSTRY/manufacturing facility

VACANT/not in use

7. Description

Architectural Classification

(Enter categories from instructions.)

NO STYLE/ early to mid-20th-century industrial

Materials: (enter categories from instructions.)

Principal exterior materials of the property: Brick, wood, concrete

Narrative Description

(Describe the historic and current physical appearance and condition of the property. Describe contributing and noncontributing resources if applicable. Begin with a **summary paragraph** that briefly describes the general characteristics of the property, such as its location, type, style, method of construction, setting, size, and significant features. Indicate whether the property has historic integrity.)

Summary Paragraph

The Standard Paper Box Corporation complex is a group of four attached, predominantly brick, 1- and 2-story industrial buildings occupying much of a city block on a roughly 2-acre parcel in a mixed industrial and residential neighborhood of Pawtucket, Rhode Island. Construction of this complex was begun in 1914 by the Standard Paper Box Corporation (1912-1933) and expanded by this company and subsequent owner Douglas Young, Inc. until 1970. During this period the facility has been used for the manufacture of boxes and as well as other forms of packaging and display materials, predominantly for the jewelry trade. Three of the four buildings are contributing resources.

Narrative Description

The Standard Box Corporation factory is located in the largely residential neighborhood of Pleasant View in eastern Pawtucket. Pleasant View and the adjoining neighborhood of Darlington to the south had been part of a sparsely developed rural district known as the Plains until the decades after the Civil War, when they were developed to accommodate the city's expanding manufacturing and associated population growth. The Providence and Worcester Railroad line (now the George R. Bennett Highway) attracted factory development; outside the industrial corridor, the land was platted for residential use. The Standard Box building occupies nine lots, comprising a little over one acre, of the 1871 Bates Plat, the majority of which was residentially developed. However, the Kenyon Avenue site is also on the eastern periphery of the industrial corridor; when factory construction began in 1914, its neighbor to the west was the immense Burgess (later Greenhalgh) Mill, a producer of cotton cloth.¹

The property was purchased by Douglas Young, Inc. in 1933. During Young's tenure, he expanded the complex to three connected buildings in a series of phases from ca. 1939 to 1961. The company also purchased land from the neighboring Greenhalgh Mill, doubling the lot size to the roughly 2-acre present parcel, and built a fourth metal building (non-contributing) there in 1970.

The three contributing buildings of this complex possess historical integrity as examples of early- to mid-20th-century industrial building practices. Despite expansion carried out over almost 50 years, Standard Paper Box and successor company Douglas Young, Inc. maintained a unified design over the nearly unbroken 225' of brick façade with segmental arch windows. This Kenyon Avenue façade survives today in excellent condition. Building No. 4, the most recent building (1970, Non-Contributing), is a metal Butler-type utility building erected in the rear lot after the period of significance.

¹ This sprawling plant (1906), one of the last major cotton plants built in Pawtucket and located immediately behind Standard Paper Box, was destroyed in a spectacular fire in 2003. This fire also claimed several houses in the area.

Inventory

Building 1

Standard Paper Box Corporation Main Building (1914, ca. 1939, Contributing)
110 Kenyon Avenue

This is a brick, 2-story, L-plan building comprising a 50' x 160' main wing and a rear, 70' x 50' ell built for storage and, later, shipping. The foundation is granite; the roof is shallow pitched gable. Erected in 1914 as a single-story factory building with front office space, the second owner, Douglas Young, Inc., added a second floor ca. 1939. Design details of this addition match those of the original construction. Perhaps to minimize work interruption, Douglas Young left the old roof intact, building the second floor over the gable, leaving the original shallow gable roof still visible in the first floor factory space. The roof (as well as all roofs of Buildings 2 and 3) is membrane covered. A single brick chimney rises from the rear corner of this wing, likely raised ca. 1939.

The main entrance on the Kenyon Avenue (east) facade is a single paneled wooden door with a transom light set in a segmental arch opening. An unused side entrance on the south wall (near front of the building) is now plywood-sheathed. Windows are segmental arch in either paired or single openings. Paired and single windows contain double-hung, 6/6 frame sash with a fixed, 6-light transom. These transoms were not milled to fit the segmental arch; a wooden panel rises from the transom to conform to the arch. While ground-level windows on the façade are covered with plywood panels, most of the remaining windows appear to be original. Sills are concrete.

The original rear ell, extending northerly from the main block, was about 50'-square. Ca. 1939 Douglas Young expanded this storage area about 20' to the north for the creation of a brick and concrete loading dock. This addition yielded the present dimensions of Building 1. The dock comprises two garage bays and two multi-light windows set in rectangular openings.

Interior framing is chamfered, square-section timber columns supporting slow-burning, plank floors. The front section of the building housed office space. The addition of the second floor expanded this office space along with manufacturing space in the rear. This partitioned space, although altered and reconfigured over decades of successive owners, has some surviving beadboard wainscoting as well as other millwork.

The south wall of this building has a surviving, roughly 90-foot length of this shafting and an in-situ 5 HP AC General Electric motor (ca. 1915), now disconnected. Although the main steel shaft has been cut in two places to accommodate later changes in the building, it is generally intact—including bearing journals (with shrouds fabricated from tin cans to eliminate oil spatter), and pulleys for several machines. A subordinate and shorter length of shaft running parallel to the main shaft is located along the ceiling about 15' to the north. This secondary shaft (lacking any accommodation for its own motor) appears to have been driven by a leather belt from the main shaft. Several runs of cloth-covered ceiling wire in the vicinity of this secondary shaft (now disabled) appear to date to the original construction as well.

Building 2

Standard Paper Box Corporation/Douglas Young, Inc. Store House
(between 1917 and 1923, additions made between 1939 and 1949, Contributing)
110 Kenyon Avenue

This is a complex building comprising a core, 50' x 80', single-story frame, flat-roofed structure built in the early years of Standard Paper Box, and several additions by Douglas Young. Used as a store house, the core building is sited about 20' north of Building 1 and set back an equal distance from Kenyon Avenue. Originally sided with clapboard, two remnants of these once-exterior walls survive, one visible from the rear parking lot and one within the plant. Nine original exterior 10/10 double-hung, wood frame windows survive on the exterior wall remnant. Interior columns are chamfered, square-section timber.

The Store House maintained its original dimensions until the period from 1939 to 1949, when additions affecting all sides of the building were carried out by Douglas Young, effectively enclosing the building within a shell of new construction.

First addition.² Douglas Young created an infill loading dock in the 20'-wide space separating the store house from Building No. 1. This predominantly concrete structure, about 50' deep, is notable for its large, steel skylight with wire-glass glazing.

Second addition. Douglas Young infilled the area of the former setback along Kenyon Avenue in front of the store house. As Young had done with the added story of Building 1, he used the segmental arch window and brick wall design of the original building for this addition. A carpenter shop is still in active use in this section of Building 2.

Third addition. Douglas Young expanded the store house to the north about 50', again maintaining the design of the brick façade with segmental arch windows. The addition has a timber framed roof supported by heavy timber posts and beams. This addition created a loading dock at a 45-degree notch the northwest corner. This former exterior dock is now on the interior (opening into Building 3, q.v.). A similar notch of unknown date occurs along Kenyon Avenue at the southeast corner of this building where a modern doorway opens onto the street.

Building 3

Douglas Young, Inc. Factory Building (1961, contributing)
110 Kenyon Avenue

Attached to Building 2, this is a single-story, cement block building with brick facing along the Kenyon Avenue elevation. Interior columns are steel, some on raised concrete footings. The floor is concrete; the roof is flat and framed with steel girders. An enclosed cement block loading dock projects from the north wall. Side and rear windows are steel frame. Front windows are wood-frame, set in segmental arch openings with concrete sills; all are plywood-sheathed. The former loading dock at the northwest corner of Building 2 now opens into this building.

² Note that the numbering of these additions is solely for the purposes of description. It is unknown whether they were carried out simultaneously or separately over a period of several years.

Building 4

Douglas Young Utility Building (1970, Non-Contributing)
110 Kenyon Avenue

The original property line for Standard Paper Box hugged the back side of Building 1 and extended to the adjoining property to the north. Ca. 1969 Douglas Young Realty³ purchased property from the neighboring Greenhalgh Mill for the construction of a Butler-type utility building and creation of a sizable rear parking lot.

This is a 100' x 50', single-story, building attached to the rear of Building 1 and set on a concrete pad. Walls and roof are corrugated steel panel.

8. Statement of Significance

Applicable National Register Criteria

(Mark "x" in one or more boxes for the criteria qualifying the property for National Register listing.)

- A. Property is associated with events that have made a significant contribution to the broad patterns of our history.
- B. Property is associated with the lives of persons significant in our past.
- C. Property embodies the distinctive characteristics of a type, period, or method of construction or represents the work of a master, or possesses high artistic values, or represents a significant and distinguishable entity whose components lack individual distinction.
- D. Property has yielded, or is likely to yield, information important in prehistory or history.

Criteria Considerations

(Mark "x" in all the boxes that apply.)

- A. Owned by a religious institution or used for religious purposes
- B. Removed from its original location
- C. A birthplace or grave
- D. A cemetery
- E. A reconstructed building, object, or structure

³ Douglas Young, Inc. formed a subsidiary company, Douglas Young Realty, in 1952. At that time all property was transferred to this entity.

F. A commemorative property

G. Less than 50 years old or achieving significance within the past 50 years

Areas of Significance

(Enter categories from instructions.)

INDUSTRY

ARCHITECTURE

Period of Significance

1914-1964

Significant Dates

1914

1933

Significant Person

(Complete only if Criterion B is marked above.)

Cultural Affiliation

Architect/Builder

unknown

Statement of Significance Summary Paragraph (Provide a summary paragraph that includes level of significance, applicable criteria, justification for the period of significance, and any applicable criteria considerations.)

The Standard Paper Box Corporation plant is significant on the state level under National Register **Criterion A** as an example of how the prominent regional jewelry industry stimulated and supported a diverse network of medium- and small-scale manufacturers that provided essential services to the jewelry manufacturers concentrated in the Providence-Pawtucket-Attleboro area from the mid-19th century through the mid-20th century. The history of the Standard Paper Box Corporation/Douglas Young Company (1914-

1970) illustrates how the local paperboard industry developed and refined specialized paper box production in direct response to the mailing, shipping, packaging and display needs of the region's manufacturing jewelers.

The buildings of Standard Paper Box Corporation are also significant under **Criterion C** as an example of a modest-scale industrial plant that preserves the architectural and structural character of the original 1914-15 design, along with a succession of later additions that illustrate the adoption of newer structural materials while retaining the original design character of brick construction with segmental arch windows. Building 1 of this plant (1914) is also notable for surviving in-situ artifacts of an early electrical power system that bridged the 19th-century system of mechanical power transmission from a prime mover and the 20th century system of direct electric drive.

Narrative Statement of Significance (Provide at least **one** paragraph for each area of significance.)

European settlement of the area that includes present-day Pawtucket dates to the early 17th century. By the late 18th century, the Boston Road (later US Route 1), part of a colonial network of post roads, extended from the settlement along the Blackstone River in Pawtucket north to Boston. A realignment of U.S. Route 1 in the late 19th century caused a renaming of a segment of the former post road as "Old Boston Road." By the early 20th century this street, winding from its intersection with Cottage Street northeasterly through a densely-settled residential neighborhood to U.S. Route 1A at the Attleboro line, was renamed Kenyon Avenue, after Robert Kenyon, the city's then-mayor.⁴

When Pawtucket emerged as an important regional center of textile and machine manufacture in the early 19th century, industrial development was concentrated along waterpower sites on the Blackstone River. The laying out of the Boston and Providence Railroad (1830s) and the Providence and Worcester Rail Road (1847, expanded 1874) through Pawtucket and the adoption of industrial steam power through mid-century made formerly agricultural or undeveloped areas of Pawtucket attractive for manufacturing sites in post-Civil War expansion.

Although industrialized in the early 20th century, the area that includes Standard Paper Box Corporation was first platted for house lots in 1871. At that time local entrepreneur and Pawtucket landowner Frederick Bates⁵ created more than one hundred house lots arrayed along Kenyon Avenue and neighboring side streets. By 1906, with a few dozen houses built in the Bates Plat, large-scale industrialization of the area commenced with the construction of the Burgess (later Greenhalgh) Mill, a producer of cotton cloth.

In December 1912 principals Charles K. Shaw, Philip L. Benoit and William D. Wilson received a charter for incorporation of Standard Paper Box Corporation. A little more than a year later, they purchased lots 15 through 24 of the Frederick Bates Plat to the immediate northeast of the Burgess plant and began construction. The new company entered the paper box industry at a time when advances in the technological

⁴ Kenyon served as mayor over various terms from ca. 1904 to the 1920s. At that time the mayor also served as the city's chief of police. Kenyon led the police into a confrontation with Pawtucket strikers during the general textile strike of 1922, giving the order to shoot which resulted in the death of a Central Falls man.

⁵ See Pawtucket Plat Card 129: *Plat No. 1 of House Lots in Pawtucket Belonging to Frederick Bates Surveyed and Platted by Cushing and Co., September 1871*. Bates is profiled in Henry R. Caulfield, *Illustrated History of Pawtucket, Central Falls and Vicinity* (1897), pp. 248-249.

capacity of that industry were enabling it to expand into new markets created by the sustained growth of other industries with shipping and marketing needs.

Paperboard box manufacture in Rhode Island

Into the 19th century, containers for shipping, mailing, or display of goods were made typically of wood or tin. The introduction of various types of paper-based board ca. 1820 set in motion a process that resulted in a massive, late-century expansion of American paperboard box production. This growth mirrored the general expansion of American industry, urbanization and rising levels of consumption in the post-Civil War era. The box industry was dominated by the hand manufacture of “set-up” boxes, i.e., fully-assembled boxes comprising a separate base and lid,⁶ until late in the 19th century.

The manufacture of an adequate supply of paperboard for this burgeoning market was limited by hand methods. Until the 1840s, paperboard—made of pasted laminations of several thin sheets of paper to a desired thickness and rigidity—had been a laborious hand process. Ray Potter (1795-1858), a Pawtucket stationer who began experimenting with machine manufacture of paperboard in the 1840s, refined a machine for this lamination process around 1844 and expanded his operation as the Pawtucket Cardboard Company.⁷ Over time the machine manufacture of laminated paperboard (made of base sheets of pulped and compressed straw or scrap paper) gave way to the wide range of papers and board stock made possible through the Fourdrinier papermaking process (introduced in the U.S. in 1829 and adapted for paperboard manufacture by 1831), in which paper pulp (containing 97% water) is passed through a succession of compressing rollers and carried on a moving wire mesh yielding a continuous web of paper or paperboard (containing only about 3% water).

An important element in the transition from tin and wood containers to those fabricated from machine-manufactured paperboard was the general embrace of “chipboard” for packaging in the late 19th and early 20th century. This type of paperboard, introduced in England in 1817, was made from pulped scrap paper and originally hand-molded. Along with finer grades of paper, its manufacture was mechanized by midcentury. Introduced in the late 19th century for food packaging (initially for biscuits and, importantly, Kellogg’s breakfast cereals), the crude surface of chipboard could be covered with a high-quality printing paper, which made the outside of the box a placard for advertisement of its contents. By 1900 the concurrent developments of high-speed color printing (chromolithography) and halftone illustration—produced on steam-powered printing presses—were producing printed paper coatings that transformed the paperboard box industry from a shipping and storage necessity to a vital facet of modern merchandising.

Folding boxes formed by die-cutting

The dominance of the set-up box as the packaging industry standard was upended in 1879⁸ by a serendipitous discovery at the Manhattan box manufacturing plant of Robert Gair, a Scottish immigrant who established a box business in 1864. Gair’s box plant included a letterpress printing department. Letterpress printing requires extreme pressure in which a piece of paper is squeezed between a platen and a type form

⁶ An example of a typical set-up box is a shoebox with separate base and lid.

⁷ After Potter’s death in 1858, the company was renamed Rhode Island Cardboard Company, continuing in operation in Pawtucket well into the 20th century.

⁸ Gair never patented his invention. He did, however, file a patent application (US Patent Application 12-PC/406, 1879). Source: Bettendorf, 1946.

that might include text, rulings and halftone engravings. In 1879 an error in setting excessive pressure on one of his printing presses caused a straight ruling—intended to print simply as a black line on paperboard—to cut through the stock. Gair, noticing this error, realized that a platen or cylinder press could be adapted to intentionally “die-cut” the shape of an unfolded box onto a sheet of paperboard. Instead of locking up a traditional type form, a specialized form could be made that included steel cutting, scoring, or perforation dies. Over time Gair perfected the process such that a single impression of the adapted press could produce a complete paperboard box in flat form, including glue tabs. The simple act of folding and gluing along the tabs, soon automated, rendered a complete box. These boxes could then be shipped flat or fully assembled in-house.

Box manufacture for the jewelry industry

The regional jewelry industry had its origins in simultaneous developments in Providence and Attleboro in the late eighteenth century. In Providence Seril Dodge was the first jeweler to open a shop in Providence in 1784, and his nephew, Nehemiah Dodge, followed him with his own shop in 1794, where he developed an early process for rolled plated gold. A Frenchman known as the “Foreigner” or Le Fornier took up jewelry making in Attleboro c. 1780 and by the early 19th century, local artisans, Colonel Obed Robinson and Manning Richards, were operating their own jewelry shops.

From these small beginnings Providence and its smaller neighbor, Attleboro, developed into the center of jewelry manufacturing in the United States in the late nineteenth century, a position which they continued to hold for much of the twentieth century. The jewelry industry grew steadily if not rapidly in the early nineteenth century. In 1830 there were twenty-seven jewelry firms employing 280 workers in Providence; by 1850, there were fifty-seven firms and 590 workers. The city’s prominence as a jewelry center served to attract both native and foreign craftsmen. Two trends that came to characterize the Providence jewelry industry were the production of jewelry in the lower price ranges, and the specialization and innovation in the technology of jewelry manufacture.

The Panic of 1857, and the Civil War retarded the industry as a whole but the postwar economic boom stimulated unprecedented growth. From forty-five shops employing over 700 workers in 1865, the Providence industry expanded to 130 companies with almost 2,700 workers by 1875. By 1880, Rhode Island was the leading state in the manufacture of jewelry, and together with Attleboro, accounted for more than one quarter of the entire national, jewelry production. By 1890, Providence’s numbers had grown to more than 200 firms with almost 7,000 workers. Attleboro, including the newly created town of North Attleborough, was home to around 90 firms. This extensive growth in the final quarter of the nineteenth century was the result of an expanding market for inexpensive jewelry, the growing labor force, fed by immigration, and the process of mechanization which began to transform the industry.

Between 1885 and 1920, costume jewelry manufacture in southern New England quadrupled, half of that increase occurring in the decade between 1910 and 1920.⁹ This rapidly expanding industry generated a concurrent demand for a wide variety of auxiliary services. Most of these services supported the manufacturing process, such as: enameling; electroplating; refining; tool-making; supply houses selling abrasives, buffing and polishing compounds; and suppliers of leather belting. One service in particular

⁹ Source: “After Thirty Years,” *The Manufacturing Jeweler* 55 (29 October 1914): 5.

addressed the critical area of marketing and distribution – the paper box industry- which produced boxes of various types, both plain and fancy, for shipping, packaging, and point-of-purchase displays.

In 1874 Providence inventor Charles A. Young established a business in an area south of downtown Providence that was becoming a center of jewelry manufacture. In that same year Young and local mechanic Solomon W. Young (no apparent relation) had received a patent¹⁰ for a type of paperboard roll to substitute for the wooden rolls then in common use in the mechanized winding of finished cotton cloth. Soon Young successfully adapted this technology for the manufacture of paperboard mailing tubes. Along with this product, he began the manufacture of “fancy paper boxes,” often lined with plush, satin or velveteen, for the jewelry industry. Young’s sons, Frank N. and Arthur L., took over the business in 1883, renaming the company Young Brothers. In 1901 Frank N. Young¹¹ (1860-1920) received a patent for a significant improvement on Gair’s die-cut folding box of 1879. This patent, “Folding paper box,”¹² introduced the idea of locking tabs, in which folding boxes (as opposed to the earlier set-up type) were die-cut with appropriate notches and slits for easy and secure assembly, eliminating some or all of the necessity of gluing (see *Additional Information*, Figure 1).

Frank N. Young’s son, Lewis Douglas Young (1892-1968, known as Douglas) worked in various capacities in jewelry box manufacturing as a young man, joining the family business by 1921.¹³ Young remained with Young Brothers until 1932. Soon after, he played a pivotal role in the story of Standard Paper Box Corporation of Pawtucket, R.I.

Standard Paper Box Corporation

In December 1912, the Rhode Island General Assembly granted a charter for a corporation engaging in the business of

manufacturing, buying, selling and generally dealing in cardboard, paper, paper substitutes, paper boxes, paper goods of all kinds, calendars, advertising novelties and specialties, and such novelties as can be manufactured from cardboard, paper, wood, cloth, leather, glass, minerals [and] metals...¹⁴

¹⁰ Charles A. Young, U.S. Patent 147,541, *Improvement in rolls for cloth winding machines*. Issued February 17, 1874.

¹¹ Upon graduation from Bryant and Stratton School of Business ca. 1880, Frank N. Young served an apprenticeship at the newly-established Providence jewelry firm, Martin, Copeland. He left that firm in 1883 to become a partner in the family box manufacturing business, bringing his knowledge of jewelry to the operation. Young Brothers branched out at this time to include a line of jewelers’ supplies. See obituary of Frank N. Young, *The Jewelers’ Circular* (22 December 1920): 77.

¹² U.S. Patent 680,105, issued August 6, 1901.

¹³ According to a biography of Frank N. Young published at <http://www.findagrave.com/cgi-bin/fg.cgi?page=gr&GRid=6474037> by great-granddaughter and Rhode Island resident Sue Williams, “Frank and his brother Arthur L. owned a fancy paper box company. When Frank died [December 1920], the business was left to Arthur and Frank’s two sons [Everett and Douglas]. Arthur and Everett conspired to bilk Douglas out of his share. Douglas caught them but decided to wire tap their phone and take the information to court, suing his brother and uncle. This was the first time that wire-tapping was used successfully in a court of law. Douglas won, but all proceeds from the company were lost by that time.” *Accessed June 27, 2014*.

¹⁴ R.I. Secretary of State, Private Acts Vol. 4, P. 219. Incorporation of Standard Paper Box Corporation, December 28, 1912.

The principals of this company, Philip L. Benoit, Charles K. Shaw and William D. Wilson, entered a thriving, but crowded field of Rhode Island paper box manufacturers—mostly in the Providence metropolitan area.¹⁵

At the time of incorporation, the principals purchased the assets of the Pawtucket Box Company, a paper box manufacturer established in 1900, and set up business at the downtown Pawtucket location.¹⁶ They also established a branch operation in Woonsocket in space leased from Frederick Colwell, a well-established commercial printer and paper box maker.

In early 1914, the Standard Paper Box company erected an L-plan, single-story, brick factory on the lots it had purchased on Kenyon Avenue, northeast of downtown Pawtucket.¹⁷ Although little is known of the day-to-day operation of Standard Paper Box Corporation, *Annual Reports of Factory Inspection* and property tax valuations over a twenty-year period provide some insight into the extent and expansion of the operation. Tax valuations show a significant rise from a simple land value in 1914 (\$9,600) to a land value of \$11,600 and tangible property of \$5,000 in 1915. At this time, seven men and fifteen women were employed.

The original brick plant measured 50' x 160' with a rear, roughly 50'-square ell used for storage. The source of mechanical power and lighting for the operation was electricity. (*The significance of surviving artifacts of this electrification is discussed below.*) In 1920, tax valuations indicate a sizable expansion of the plant, a 50' x 75' frame storehouse (Building 2) sited north of the main factory and the sole expansion of the plant during the ownership of Standard Paper Box from 1914 to 1933. (See *Additional Information*, Figure 2)

As noted earlier, paper box manufacturers typically produced either folding boxes formed from a die-cut piece of flat paperboard or fully-assembled “set-up” boxes with lids. Standard Paper Box advertisements from the Providence City Directory in the period from 1919-1921 note that the company manufactured “every kind of paper boxes [sic]—except folding boxes.” (See *Additional Information*, Figure 3). This odd insertion suggests that Standard Paper Box was constrained, perhaps by the threat of patent litigation, from the manufacture of folding boxes. Another indicator of business difficulties was the departure of principal Charles Shaw in 1919 and his subsequent formation of a competing firm in Pawtucket, Shaw Paper Box Company, in the same year.¹⁸

At Woonsocket, it appears that the Standard Paper Box branch operation coexisted with Frederick Colwell’s box-making department until 1920, at which time Standard Paper Box purchased the company outright,¹⁹ only to close the branch and sell all machinery two years later.

A classified ad²⁰ placed in the July 1922 issue of the paper box trade journal *Shears* noted the closing of the Woonsocket branch and the sale of thirteen pieces of box-making machinery (see *Additional Information*, Figure 4). The list provides the only documentation available as to the complement of machinery used by

¹⁵ There were nine such companies operating in Providence, Pawtucket, Central Falls and Woonsocket and listed in the *Annual Report of the Commissioner of Industrial Statistics*, 1911. Eight were in the Providence-Pawtucket area.

¹⁶ The address of this factory was 19 Hamilton Street. This street, which ran between Blackstone and Exchange, was abandoned in the mid-20th century for the construction of an elderly high-rise.

¹⁷ Pawtucket Land Evidence Book 163: 168 (31 March 1914).

¹⁸ The other original principal, William D. Wilson, also left the company around this time.

¹⁹ Source: *The Jewelers’ Circular* (January 1920): 115d.

²⁰ *Shears* 30 (July 1922): 166.

the company during its twenty-year existence and confirms its focus on the manufacture of “set-up,” as opposed to folding boxes.²¹

While property tax valuations remained stable from 1920 to 1932, *Annual Reports of Factory Inspection* show a general increase in employment from 22 operatives in 1915 to 52 employees at the time of bankruptcy filing in 1933. Evidence of the production of a wide range of “fancy boxes” for the jewelry industry can be gleaned from a list of creditors in the bankruptcy filing: vendors included suppliers of ribbon, gold stamping, wadding (for placement of jewelry within boxes), adhesives, metal clasps, paperboard, and engraving services.²² These documents reveal Standard Paper Box to be caught in a common Depression-era squeeze—customers unable to pay for purchased goods and creditors demanding payment. Assisting the owners in maintaining payroll through the difficulties was Douglas Young, who infused several thousand dollars into the struggling box company in April 1933. A month later he made an offer to the court-appointed receiver to purchase the company and acquired all assets at public auction in late May.²³

Douglas Young, Inc.

Young renamed the company Douglas Young, Incorporated. Young was able to maintain generally steady employment for his operatives through the Depression years. In the World War II era, Young undertook a significant expansion of the plant. This included the addition of a second story to the original 1914 factory building as well as an expansion of the rear ell. Young also commenced an expansion of the early frame store house that brought its façade (now brick) out to Kenyon Avenue from its original setback, as well as expanding it to the north. It is notable that Young chose to replicate important design elements of the original building—single-story brick construction, exposed rafter ends and multi-light wood-frame, segmental arch windows—long after steel framing, steel windows and cement block walls had become common in post-war factory construction. A final expansion in 1961 extended the façade further north along Kenyon Avenue to the present-day dimensions (see *Additional Information*, Figure 6). While incorporating interior steel columns and cement block construction along the rear and north walls, Young once again chose to maintain the unified brick façade visible along Kenyon Avenue today.

Shortly after his acquisition of Standard Paper Box Corporation, Douglas Young, in the footsteps of his father and grandfather, received his first U.S. Patent, entitled *Box*,²⁴ for a specialized type of jewelry display box (see *Additional Information*, Figure 5). A vigorous inventor, Young went on to secure forty more patents for various aspects of box and display design until 1967, a year before his death. It is worth noting that Young, the son of the holder of a major patent for folding boxes, likely was not burdened by licensing constraints on the production of this type of box.

²¹ Robert F. Salade’s 1920 handbook, *How Paper Boxes are Made* (see Bibliography), lists standard complements of machinery recommended for the two types of paper box manufacture. This list of equipment for sale comports well with Salade’s recommendations for set-up box manufacture. Pages 13-49 describe in some detail the necessary operations for manufacture of this type of box.

²² Source: Exhibit B, R.I. Equity Case 12058: *Philip L. Benoit vs. Standard Paper Box Corporation*, August 29, 1933. On file, RI Judicial Records Center, Pawtucket, RI.

²³ Douglas Young last appears as a principal of Young Brothers in 1932 directory listings. The auction date was May 29, 1933 as recorded in Pawtucket Land Evidence Book 323: 14.

²⁴ US Patent 2,052,157, issued August 25, 1936.

Douglas Young died in 1968. Donald Barrengos became president of the company after Young's death, and in 1971, acquired the company. The company continued operations under the same name until the plant was sold to Fuller Packaging in 1987. A final improvement to the plant was made in 1970 with the erection of Building 4, a single-story, 100' x 50', Butler-type building attached to the rear of Building 1 (see *Additional Information*, Figure 7). Fuller Packaging sold the plant in 1994, at which time it was subdivided for multiple tenants. The property owner fell into receivership in 2013 and, while the plant has been mostly vacant, a few tenants remain, including an active carpenter shop in Building 2. Current owners envision a rehabilitation and adaptive reuse of the property.

Factory electrification

Although no machinery related to box manufacture survives at Standard Paper Box, two lengths of millwork, i.e., steel shafting for power transmission, are found on the south wall and along the ceiling of the original 1914 factory building (Building 1). Artifacts associated with this millwork include a pre-1920, wall-mounted, 5 HP AC motor, bearing journals, and pulleys. These date to the construction of the building and are significant in-situ artifacts of an early and transitional phase of industrial electrification.

The original single-story Standard Paper Box plant was developed with a transitional form of electrical drive. By the 1890s many small and large factory owners were refitting their shops to take advantage of the benefits of electrical power, either through in-plant electrical generation or a tie-in to the emergent electrical grid. Because Pawtucket had been providing electricity from central generating plants since the 1880s (originally for lighting, then, by the 1890s, for power), Standard Paper Box was designed with shafting run high along the walls and powered by large AC motors. In this sense, the 1914 design represents a bridge between 19th-century factory layout—dependent upon a prime mover of water or steam and a system of shafting and belting to deliver motive power to the machinery—and the direct mounting of individual AC motors onto machine frames as was commonplace by the 1920s.

Beginning in the late 1890s, shop owners began to adopt electricity for motive power instead of the water- or steam power characteristic of 19th-century industrialization. The hazard of boiler explosions, seasonal variations in water supply, loss of power through friction along complex shafting, cost of coal, and a host of other concerns made electricity—furnished within the plant or through a nascent electric grid—an attractive alternative. The decade of the 1890s witnessed an ongoing battle between interests promoting direct (DC) or alternating (AC) current. The earliest dynamos (also called generators) reliably produced DC for local use, while suffering great resistance losses in distance transmission. AC, on the other hand, could be transformed to very high voltages and effectively and efficiently transmitted over great distances. The acclaimed demonstration of lighting powered by an AC plant at the World's Columbian Exposition in 1893 augured the future of electrification in the new century.

The predominant use of AC for lighting was supplemented by a number of innovations in motor design beginning with Nikola Tesla's invention of a prototype AC motor in 1883. Over the next two decades, important motor innovations, many carried out by competitors Westinghouse and General Electric, made the three-phase, synchronous AC motor a standard feature of early 20th-century industrial power.

In the absence of access to an electrical grid, many factories produced their own electrical power—either DC or AC. A steam or diesel engine—perhaps formerly used to power millwork—could be set up to drive an alternator or generator, from which wiring could be run to local motors. The physical size and power

demands of early motors, however, made their local mounting onto most machines impracticable.²⁵ During this period before the general availability of motors attachable to machine frames, factory owners sometimes mounted these large motors along walls in order to power ceiling shafts and pulleys that, in turn, powered floor machinery through leather belting, as was the case at Standard Paper Box. Local mounting of AC motors directly onto machine frames was commonplace by 1925, when three-quarters of American industry had adopted electrical drive.²⁶

The transitional nature and liabilities of the motor-driven millwork at Standard Paper Box is well-demonstrated in this excerpt from Robert Salade's 1920 handbook on paper box manufacture:

In many of the big paper box making factories practically all of the machines are driven by individual electric motors, which means that there is no wastage of electric current when all of the machines are not in motion. When individual motors are being used in a plant, no overhead shafting or belting is necessary. Overhead shafting and belting is often responsible for dirt, dust, or oil thrown on expensive material. When steam power, or a single large motor, is used in a plant, it costs money for shafting and belting, and it also costs something to operate the shafting and belting before the power reaches the machines. Belts often break and must be repaired while the machines are standing idle. All of this expense is eliminated by the individual motor system; it helps in maintaining clean work-rooms, and it saves the manufacturer a considerable sum of money on account of the electrical current being consumed only at points where the machines are in operation.²⁷

Although the survival of these two lengths of millwork suggests their continued use in the Douglas Young period, by the time Young acquired Standard Paper Box in 1933, it is likely that he needed little convincing as to the benefits of individual motors.

A note on Pawtucket mill electrification

In 1896 a group of Pawtucket industrialists and investors formed the Pawtucket Electric Company

for the purpose of distributing, selling, leasing and using electricity for lighting, heating, mechanical, motive and other purposes and for manufacturing, using and dealing in all machinery, instruments, and apparatus pertaining to the generation, distribution, or use of electricity, with power to acquire such rights and franchises related to the conducting of electricity through, over, and or under the highways of Pawtucket and adjoining towns and cities...²⁸

²⁵ An interesting variation on this transitional system is found at the Royal Mill on the Pawtuxet River in West Warwick, RI (NR-listed, 2004), in which a 19th-century hydraulic turbine drove an alternator, producing current for the main textile plant as well as other industrial tenants. This equipment survives in an interpretive center within the rehabilitated mill.

²⁶ Louis C. Hunter, *A History of Industrial Power in the United States* (Vol. 3), p. 242.

²⁷ Robert F. Salade, *How Paper Boxes Are Made*, 1920, p. 47. With regard to the inevitable spatter of oil from shaft bearings and the potential damage to valuable materials, it is worth noting that as a preventive measure, large tin cans were cut in half lengthwise and hung below the bearings to catch any drip or spatter at Standard Paper Box. A number of these survive.

²⁸ Private Acts Vol. 65A, No. 1. On file, RI State Archives. Incorporation of Pawtucket Electric Company. Among the incorporators were textile industrialists Darius Goff, Lyman Darling, Stephen Jenks, and Hezekiah Conant. A previous company, Pawtucket Electric Lighting Company, had been chartered in 1882 for the sole purpose of providing electricity for lighting. The successor to Pawtucket Electric Company was Blackstone Valley Gas and Electric Company, chartered in 1912.

Despite the limitations of a local grid, the following year this new corporation placed an ad in the Pawtucket City Directory with the exhortation: *Operate your shops with electricity! Convenient—Clean—Cheap.*

A decade later, successful expansion of this private grid allowed the company to make an even more persuasive case for electrical power in the shops and factories of the city (see *Additional Information*, Figure 8):

FACTORY POWER

Why not run your factory by ELECTRIC POWER?

It is the safest and cleanest power to be had

Is always ready

No shoveling of coal or hauling out ashes

Requires no engineer to operate

No chance for complaint of maintaining a smoke nuisance

No danger of boiler explosions

PAWTUCKET ELECTRIC COMPANY²⁹

The company found an able promoter in Robert Kenyon. In a city-financed booklet promoting the industrial possibilities of Pawtucket, *A Hive of Diversified Industries* (1910), the Pawtucket mayor noted that

The Pawtucket Electric Company with three stations making current by coal and water falls is well-prepared to furnish electricity to manufacturing concerns. Over 7,000 horse-power is now distributed to some of the large and many of the small factories.³⁰

Four years later, the principals of Standard Paper Box outfitted their factory for electrical motive power. The surviving elements of this early period of electrical power, including runs of cloth-covered wire (no longer live), are important artifacts of early 20th-century industrial electrification.

²⁹ Pawtucket City Directory, 1905.

³⁰ Robert Kenyon, *A Hive of Diversified Industries*, p. 14. The extent of factory electrification from the 1890s to the time of Kenyon's writing is evident in the fact that the 1890 federal census notes 16,000 HP in use in electrified factories nationwide. Twenty years later, about half of that amount was in use in Pawtucket alone. The Bridge Mill Power Plant, one of the three electrical generating stations mentioned by Kenyon, survives at 25 Roosevelt Avenue. This facility was listed in the National Register in 1983.

Developmental history/additional historic context information

No. 680,105.

Patented Aug. 6, 1901.

F. N. YOUNG.
FOLDING PAPER BOX.
(Application filed May 4, 1901.)

(No Model.)

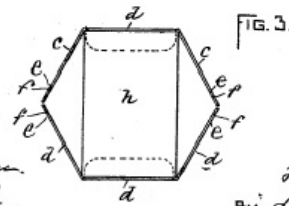
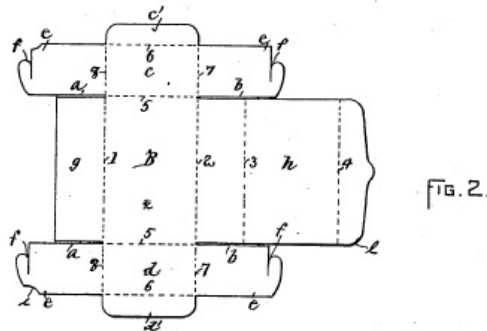
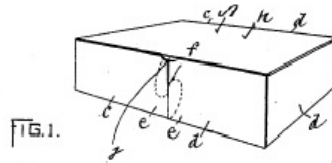

WITNESSES:

Wm. J. Cannon
J. B. Lynch

INVENTOR:

Frank N. Young
BY *A. Scholfield*
ATTY

Figure 1

Folding Paper Box, U.S. Patent 680,105, issued August 6, 1901

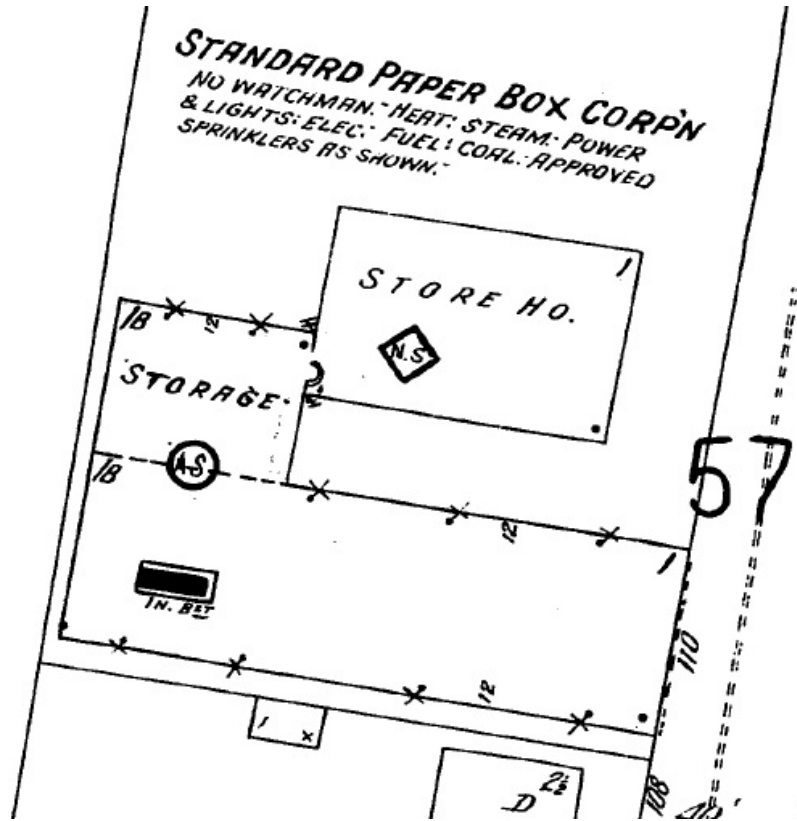

Figure 2

Detail from 1923 Sanborn Fire Insurance Map showing single-story, L-plan Main Building (Building 1, 1914) and frame Store House (Building 2, ca. 1920)

PHILIP L. BENOIT, Pres.	CHAS. K. SHAW, Sec'y-Treas.
Standard Paper Box Corporation	
Manufacturers of	
<i>Every Kind of Paper Boxes</i>	
Except Folding Boxes	
OFFICE and PLANT 110 KENYON AVENUE	Pawtucket, Rhode Island

Figure 3

Display advertisement, Providence City Directory, 1919

FOR SALE--We have discontinued our branch factory and have the following machinery in good condition for sale: Kingsbury & Davis Double Ender, No. 2 and 22 forms; Robinson Clutch Type Double Scorer, 45x45; Robinson Powerfeed Single Scorer; Hobbs Double Corner Cutter; 36" Acme Power Paper Cutter; No. 2 Robinson Ender and 6 forms; Blessing Flange Bender; 2 No. 7 Stayers; 1 10" Lynn Stripper; 1 12" Lynn Stripper; 1 12" Robinson Topper; 1 16" Lynn Topper; 1 Foot Thumber, Marshall; 1 Hobbs Junior Stripper. Standard Paper Box Corporation, 110 Kenyon avenue, Pawtucket, R. I.

Figure 4

Classified advertisement published in trade magazine *Shears* (July 1922) listing complement of machinery used in the manufacture of "set-up" boxes

Aug. 25, 1936.

L. D. YOUNG

2,052,157

BOX

Filed Aug. 15, 1935

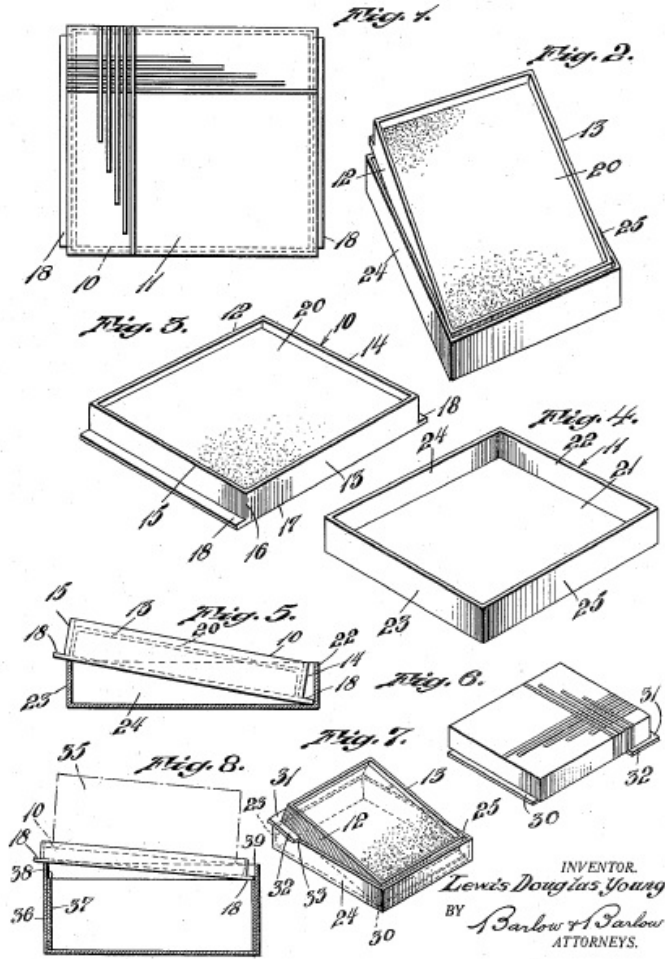

Figure 5

Box, U.S. Patent 2,052,257, issued August 25, 1936

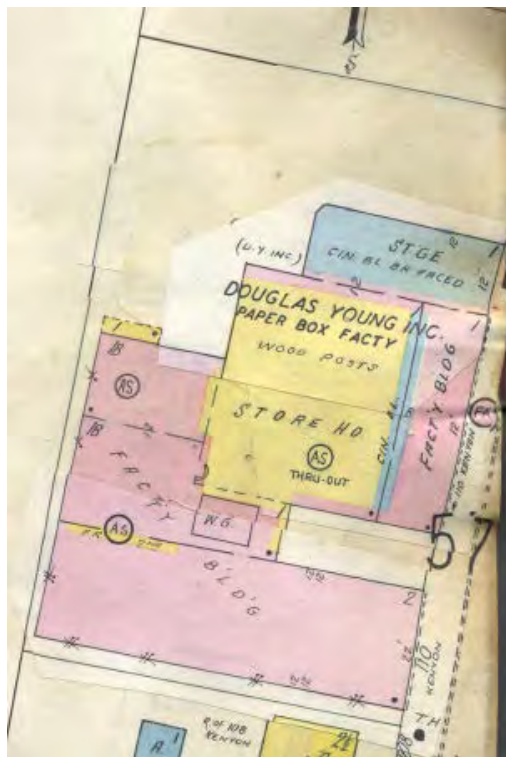

Figure 6
 Detail from 1962 Sanborn Fire Insurance Map
 showing series of enlargements to original Standard Paper Box Store House
 and infill between Store House (Building 2) and Building 1

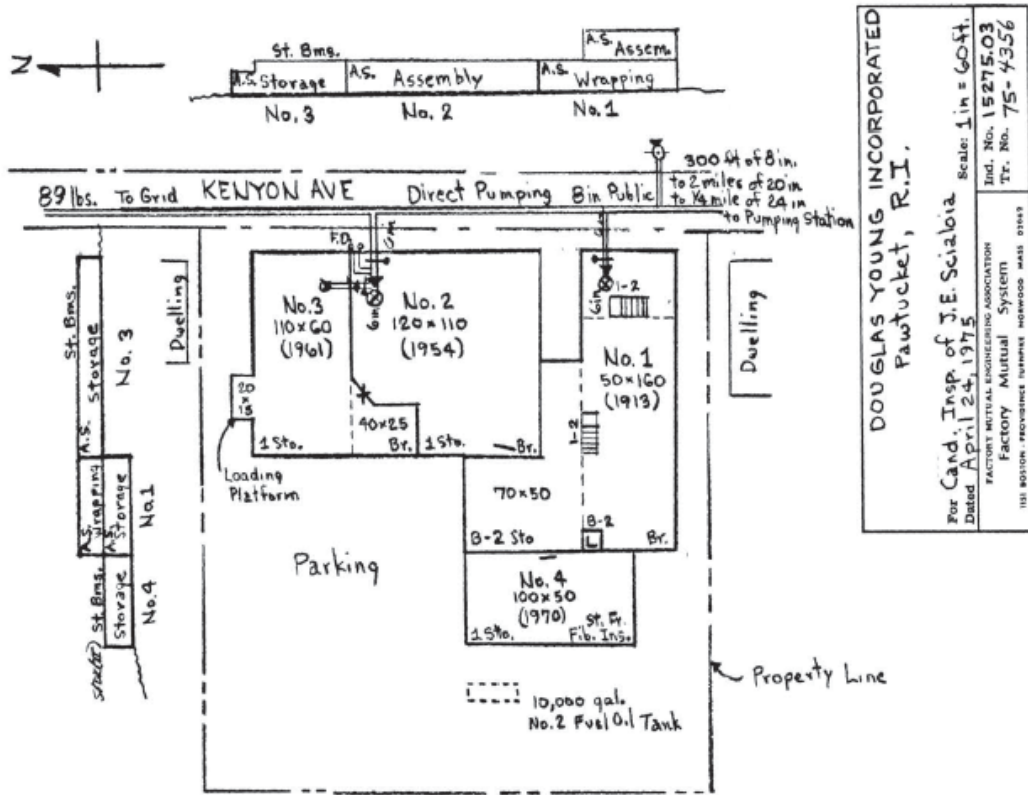

Figure 7
 Factory Mutual drawing (1975)
 Douglas Young, Incorporated
 showing current conditions
Note: some dates on this drawing are incorrect

FACTORY POWER

Why not run your factory by **ELECTRIC POWER**? It is the safest and cheapest power to be had
 Is always ready. No shoveling of coal or hauling out ashes
 Requires no engineer to operate
 No chance for complaint of maintaining a smoke nuisance. No danger of boiler explosions

PAWTUCKET ELECTRIC COMPANY
 SLATER TRUST COMPANY BUILDING

Figure 8
 Display advertisement, Pawtucket City Directory, 1905

9. Major Bibliographical References

Bibliography

Articles:

“After Thirty Years.” *The Manufacturing Jeweler* LV (29 October 1914): 5.

“Paper Box Making.” *Scientific American* XVII (19 May 1894): 309.

Books and monographs:

A Chronological History of Electrical Development.

New York, National Electrical Manufacturers Association, 1946.

Bettendorf, Harry J. *Paperboard and Paperboard Containers, a History.*

Chicago: Board Products Publishing Co., 1946.

Hunter, Louis C. and Lynwood Bryant. *A History of Industrial Power in the United States, 1780-1930* (Vol. III). Cambridge, MA: MIT Press, 1991.

Kenyon, Robert: *Pawtucket: A Hive of Diversified Industries*

Pawtucket, RI: City of Pawtucket, 1910.

Passer, Harold C. *The Electrical Manufacturers, 1875-1900,*

Cambridge, MA: Harvard University Press, 1953.

Pawtucket Past and Present. Pawtucket: Slater Trust Company, 1917.

Salade, Robert F. *How Paper Boxes Are Made*

Lafayette, IN: Shears Publishing Company, 1920.

Weaver, Alexander. *Paper, Wasps and Packages*

Chicago: Paper Corporation of America, 1937.

Government publications:

State of Rhode Island, *Annual Reports of Factory Inspection* (1915-1937)

Pawtucket Tax Records (1913-1967)

Unpublished material:

Land Evidence, Pawtucket, Rhode Island.

Rhode Island Equity Case 12058 (1933)

Book 30, Page 1006. *Philip L. Benoit vs. Standard Paper Box Corporation*
On file, Rhode Island Judicial Records Center, Pawtucket, RI.

Maps and drawings consulted:

Listed chronologically

- 1871 Cushing and Co. *Plat No. 1 of House Lots in Pawtucket Belonging to Frederick Bates Surveyed and Platted by Cushing and Co., September 1871.*
Plat Card 129.
- 1917 Richards Map Co. *Atlas of the Providence Metropolitan District.*
- 1923 Sanborn Fire Insurance Map, Pawtucket, RI, Sheet 56.
Also 1949, 1962, 1978, 1984.
- 1975 Factory Mutual System. *Douglas Young Incorporated* (Drawing 75-4356).

United States Patent Office:

680,105 Frank N. Young. *Folding Paper Box.* 6 August 1901.

2,052,157 Lewis Douglas Young. *Box.* 25 August 1936.

Note: This is the first of some forty patents issued to Douglas Young between 1936 and 1967 for inventions related to box and display manufacture.

Previous documentation on file (NPS):

- ___ preliminary determination of individual listing (36 CFR 67) has been requested
- ___ previously listed in the National Register
- ___ previously determined eligible by the National Register
- ___ designated a National Historic Landmark
- ___ recorded by Historic American Buildings Survey # _____
- ___ recorded by Historic American Engineering Record # _____
- ___ recorded by Historic American Landscape Survey # _____

Primary location of additional data:

State Historic Preservation Office

Other State agency

Federal agency

Local government

University

Other

Name of repository: _____

Historic Resources Survey Number (if assigned): _____

10. Geographical Data

Acreeage of Property 1.74 acres

Use either the UTM system or latitude/longitude coordinates

Latitude/Longitude Coordinates (decimal degrees)

Datum if other than WGS84: _____

(enter coordinates to 6 decimal places)

1. Latitude: _____ Longitude: _____

2. Latitude: _____ Longitude: _____

3. Latitude: _____ Longitude: _____

4. Latitude: _____ Longitude: _____

Or

UTM References

Datum (indicated on USGS map):

NAD 1927 or NAD 1983

1. Zone: 19 Easting: 303752 Northing: 4640202

2. Zone: _____ Easting: _____ Northing: _____

3. Zone: _____ Easting: _____ Northing: _____

4. Zone: _____ Easting : _____ Northing: _____

Verbal Boundary Description (Describe the boundaries of the property.)

The boundaries of Standard Paper Box Corporation are contiguous with those of Pawtucket, RI Assessors Map 9, Lot 565.

Boundary Justification (Explain why the boundaries were selected.)

These boundaries represent the original lot as acquired by Standard Paper Box Corporation in 1914 supplemented by the additional rear property acquired by successor company Douglas Young, Inc. in 1969.

11. Form Prepared By

name/title: Edward Connors
organization: Edward Connors and Associates
street & number: 39 Dyer Avenue
city or town: Riverside state: RI zip code: 02915
e-mail nconnors@cox.net
telephone: 401 595-0699
date: July 2014

Additional Documentation

Submit the following items with the completed form:

- **Maps:** A **USGS map** or equivalent (7.5 or 15 minute series) indicating the property's location.
- **Sketch map** for historic districts and properties having large acreage or numerous resources. Key all photographs to this map.
- **Additional items:** (Check with the SHPO, TPO, or FPO for any additional items.)

Photographs

Submit clear and descriptive photographs. The size of each image must be 1600x1200 pixels (minimum), 3000x2000 preferred, at 300 ppi (pixels per inch) or larger. Key all photographs to the sketch map. Each photograph must be numbered and that number must correspond to the photograph number on the photo log. For simplicity, the name of the photographer, photo date, etc. may be listed once on the photograph log and doesn't need to be labeled on every photograph.

Photo Log

Photo Log

Name of Property: Standard Paper Box Corporation
City or Vicinity: Pawtucket
County: Providence State: RI
Photographer: Edward Connors
Date Photographed: September 2014

View of Building 1 façade and north elevation, camera facing southwest
1 of 14.

Name of Property: Standard Paper Box Corporation
City or Vicinity: Pawtucket
County: Providence State: RI
Photographer: Chris Fagan
Date Photographed: Jan 2014

(l-r) View of Buildings 1, 2 and 3, camera facing southwest
2 of 14.

Name of Property: Standard Paper Box Corporation
City or Vicinity: Pawtucket
County: Providence State: RI
Photographer: Edward Connors
Date Photographed: September 2014

View of Building 2 at corner of alleyway, camera facing northwest
3 of 14.

Name of Property: Standard Paper Box Corporation
City or Vicinity: Pawtucket
County: Providence State: RI
Photographer: Edward Connors
Date Photographed: September 2014

View of alleyway and loading dock between Buildings 1 (l) and 2 (r), camera facing west
4 of 14.

Name of Property: Standard Paper Box Corporation
City or Vicinity: Pawtucket
County: Providence State: RI
Photographer: Edward Connors
Date Photographed: September 2014

Rear elevation of complex showing (l-r) Buildings 3, 2, 1 and 4, camera facing southeast
5 of 14.

Name of Property: Standard Paper Box Corporation
City or Vicinity: Pawtucket
County: Providence State: RI
Photographer: Edward Connors
Date Photographed: September 2014

View of (l-r) portion of Building 3, exposed frame section of Building 2, and Building 1 shipping dock,
camera facing southeast
6 of 14.

Name of Property: Standard Paper Box Corporation
City or Vicinity: Pawtucket
County: Providence State: RI
Photographer: Chris Fagan
Date Photographed: Jan 2014

Interior view of Building 1 (first floor), camera facing southwest
7 of 14

Name of Property: Standard Paper Box Corporation
City or Vicinity: Pawtucket
County: Providence State: RI
Photographer: Chris Fagan
Date Photographed: Jan 2014

Interior view of Building 1 (2nd floor), camera facing west
8 of 14.

Name of Property: Standard Paper Box Corporation
City or Vicinity: Pawtucket
County: Providence State: RI
Photographer: Chris Fagan
Date Photographed: Jan 2014

Interior view of Building 2, camera facing east
9 of 14.

Name of Property: Standard Paper Box Corporation
City or Vicinity: Pawtucket
County: Providence State: RI
Photographer: Chris Fagan
Date Photographed: August 2014

Interior view of Building 2, camera facing south
10 of 14.

Name of Property: Standard Paper Box Corporation
City or Vicinity: Pawtucket
County: Providence State: RI
Photographer: Chris Fagan
Date Photographed: August 2014

Interior view of fourth addition to Building 2 (1954), camera facing south
11 of 14.

Name of Property: Standard Paper Box Corporation
City or Vicinity: Pawtucket
County: Providence State: RI
Photographer: Chris Fagan
Date Photographed: September 2014

Typical framing, Building 2, camera facing northeast
12 of 14.

Name of Property: Standard Paper Box Corporation
City or Vicinity: Pawtucket
County: Providence State: RI
Photographer: Chris Fagan
Date Photographed: August 2014

Interior view of Building 3, camera facing southwest
13 of 14.

Name of Property: Standard Paper Box Corporation
City or Vicinity: Pawtucket
County: Providence State: RI
Photographer: Edward Connors
Date Photographed: September 2014

View of General Electric motor and shafting, building 1
Camera facing southeast
14 of 14

Paperwork Reduction Act Statement: This information is being collected for applications to the National Register of Historic Places to nominate properties for listing or determine eligibility for listing, to list properties, and to amend existing listings. Response to this request is required to obtain a benefit in accordance with the National Historic Preservation Act, as amended (16 U.S.C.460 et seq.).

Estimated Burden Statement: Public reporting burden for this form is estimated to average 100 hours per response including time for reviewing instructions, gathering and maintaining data, and completing and reviewing the form. Direct comments regarding this burden estimate or any aspect of this form to the Office of Planning and Performance Management, U.S. Dept. of the Interior, 1849 C. Street, NW, Washington, DC.



140

NO
PARKING
HERE

JESSICA
BEAUCHAINE
WARD 4

JESSICA
BEAUCHAINE
WARD 4



NO
PARKING
ANY
TIME

OFFICE



30
320

PineAoy
CARRIERS
800-850-8500

121

NGEW





30
320

ROBROT
Construction
800-800-8000







NO
SMOKING



PLEASE NOTE
WALKWAY BEHIND
MACHINE IS NOT
SAFE TO WALK ON











UNITED STATES DEPARTMENT OF THE INTERIOR
NATIONAL PARK SERVICE

NATIONAL REGISTER OF HISTORIC PLACES
EVALUATION/RETURN SHEET

REQUESTED ACTION: NOMINATION

PROPERTY Standard Paper Box Corporation
NAME:

MULTIPLE
NAME:

STATE & COUNTY: RHODE ISLAND, Providence

DATE RECEIVED: 1/16/15 DATE OF PENDING LIST: 2/06/15
DATE OF 16TH DAY: 2/23/15 DATE OF 45TH DAY: 3/03/15
DATE OF WEEKLY LIST:

REFERENCE NUMBER: 15000055

REASONS FOR REVIEW:

APPEAL: N DATA PROBLEM: N LANDSCAPE: N LESS THAN 50 YEARS: N
OTHER: N PDIL: Y PERIOD: N PROGRAM UNAPPROVED: N
REQUEST: N SAMPLE: N SLR DRAFT: N NATIONAL: N

COMMENT WAIVER: N

 ACCEPT RETURN REJECT DATE

ABSTRACT/SUMMARY COMMENTS:

The Standard Paper Box Corporation is locally significant under National Register Criteria A and C in the areas of Industry and Architecture. Located amid what was Pawtucket's expanding early twentieth century industrial zone, the circa 1914 factory and its additions represent a fine local example of modest-scale industrial construction with simple brick cladding, generous segmental arch window openings, and chamfered, square-section timber columns supporting slow-burning, plank floors. The plant (1914 section) is also notable for its surviving in-situ artifacts of an early electrical power system. The Providence--Pawtucket area was a major center of jewelry manufacturing in the late nineteenth and early twentieth centuries. The continued expansion of local jewelry production led to the creation of a host of auxiliary support services, including the manufacture of custom boxes essential to the shipping, sale and marketing of jewelry. The Standard Paper Box Corporation, later Douglas Young Inc., represented such an operation, which significantly contributed to sustaining Pawtucket's rich industrial heritage.

RECOM./CRITERIA Accept Criteria A+C

REVIEWER Paul R. Lusignea DISCIPLINE HISTORIAN

TELEPHONE _____ DATE 2/24/2015

DOCUMENTATION see attached comments Y/N see attached SLR Y/N

If a nomination is returned to the nominating authority, the nomination is no longer under consideration by the NPS.



STATE OF RHODE ISLAND AND PROVIDENCE PLANTATIONS
HISTORICAL PRESERVATION & HERITAGE COMMISSION

Old State House • 150 Benefit Street • Providence, R.I. 02903-1209

TEL (401) 222-2678

FAX (401) 222-2968

TTY (401) 222-3700

Website www.preservation.ri.gov



January 13, 2015

Mr. J. Paul Loether, Chief
National Park Service 2280, 8th Floor
National Register of Historic Places
1201 I (Eye) Street, NW
Washington, DC 20005

Dear Mr. Loether:

Enclosed is the completed National Register of Historic Places nomination for the Standard Paper Box Corporation at 110 Kenyon Ave. in Pawtucket, Rhode Island.

Notification procedures required by law have been followed. The nomination has been reviewed by the Rhode Island Review Board and approved.

Pursuant to the National Historic Preservation Act of 1966, as amended in 1980, as State Historic Preservation Officer for Rhode Island, I hereby nominate this property to the National Register of Historic Places.

Sincerely,

Edward F. Sanderson

Deputy State Historic Preservation Officer

/mam
enclosure