

United States Department of the Interior  
National Park Service



RECEIVED 976  
SEP 23 2013

# National Register of Historic Places Registration Form

This form is for use in nominating or requesting determinations of eligibility for individual properties or districts. See instructions in *How to Complete the National Register of Historic Places Registration Form* (National Register Bulletin 16A). Complete each item by marking "x" in the appropriate box or by entering the information requested. If an item does not apply to the property being documented, enter "N/A" for "not applicable." For functions, architectural classification, materials and areas of significance, enter only categories and subcategories listed in the instructions. Place additional entries and narrative items on continuation sheets (NPS Form 10-900a). Use a typewriter, word processor, or computer, to complete all items.

### 1. Name of Property

historic name Bradley Beach Free Public Library

other names/site number \_\_\_\_\_

### 2. Location

street & number 511 Fourth Avenue

not for publication

city or town Borough of Bradley Beach

vicinity

state New Jersey

code 034

county Monmouth

code 025

zip code 07720

### 3. State/Federal Agency Certification

As the designated authority under the National Historic Preservation Act, as amended, I certify that this  nomination

request for determination of eligibility meets the documentation standards for registering properties in the National Register of Historic Places and meets the procedural and professional requirements set forth in 36 CFR Part 60. In my opinion, the property  meets  does not meet the National Register criteria. I recommend that this property be considered significant  nationally  statewide  locally.  See continuation sheet for additional comments.

R. J. Booy Ass't Commissioner  
Signature of certifying official/Title

9/26/13  
Date

NJ DEP  
State or Federal agency and bureau

In my opinion, the property  meets  does not meet the National Register criteria.  See continuation sheet for additional comments.

Signature of certifying official/Title

Date

State or Federal agency and bureau

### 4. National Park Service Certification

I hereby certify that this property is:

entered in the National Register.  
 See continuation sheet.

determined eligible for the National Register.  
 See continuation sheet.

determined not eligible for the National Register.

removed from the National Register.

other, (explain:)

Signature of the Keeper

Date of Action

[Signature]

12/24/2013

**5. Classification**

| <b>Ownership of Property</b><br>(Check as many boxes as apply) | <b>Category of Property</b><br>(Check only one box) | <b>Number of Resources within Property</b><br>(Do not include previously listed resources in the count.) |                 |
|--|---|--|-----------------|
| <input type="checkbox"/> private                               | <input checked="" type="checkbox"/> building(s)     | Contributing   | Noncontributing |
| <input checked="" type="checkbox"/> public-local               | <input type="checkbox"/> district                   | 1  | 1               |
| <input type="checkbox"/> public-State                          | <input type="checkbox"/> site                       | 0  | 0               |
| <input type="checkbox"/> public-Federal                        | <input type="checkbox"/> structure                  | 0  | 0               |
|  | <input type="checkbox"/> object                     | 0  | 1               |
|  |   | 1  | 2               |
|  |   |  | Total           |

|   |  |
|---|--|
| <b>Name of related multiple property listing</b><br>(Enter "N/A" if property is not part of a multiple property listing.) | <b>Number of contributing resources previously listed in the National Register</b> |
| <u>N/A</u>  | <u>0</u>   |

**6. Function or Use**

| <b>Historic Functions</b><br>(Enter categories from instructions) | <b>Current Functions</b><br>(Enter categories from instructions) |
|---|--|
| <u>EDUCATION/Library</u>  | <u>EDUCATION/Library</u>   |
| _____   | _____  |
| _____   | _____  |
| _____   | _____  |
| _____   | _____  |
| _____   | _____  |
| _____   | _____  |
| _____   | _____  |

**7. Description**

| <b>Architectural Classification</b><br>(Enter categories from instructions) | <b>Materials</b><br>(Enter categories from instructions)            |
|---|---|
| <u>LATE 19<sup>TH</sup> AND 20<sup>TH</sup> CENTURY REVIVALS: Classical</u> | foundation <u>Limestone</u>   |
| <u>Revival</u>  | walls <u>Brick accented with Limestone</u>                          |
| _____   | _____   |
| _____   | roof <u>Green glazed Ludowici tile/standing seam copper;</u>        |
|   | <u>EPDM membrane</u>  |
|   | other <u>Limestone portico with pediment and cartouche; granite</u> |
|   | <u>steps</u>  |
|   | _____   |

**Narrative Description**

(Describe the historic and current condition of the property on one or more continuation sheets.)

**8 Statement of Significance**

**Applicable National Register Criteria**

(Mark "x" in one or more boxes for the criteria qualifying the property for National Register listing.)

- A** Property is associated with events that have made a significant contribution to the broad patterns of our history.
- B** Property is associated with the lives of persons significant in our past.
- C** Property embodies the distinctive characteristics of a type, period or method of construction or represents the work of a master, or possesses high artistic values, or represents a significant and distinguishable entity whose components lack individual distinction.
- D** Property has yielded, or is likely to yield, information important in prehistory or history.

**Criteria considerations**

(mark "x" in all the boxes that apply.)

Property is:

- A** owned by a religious institution or used for religious purposes.
- B** removed from its original location.
- C** a birthplace or grave.
- D** a cemetery.
- E** a reconstructed building, object or structure.
- F** a commemorative property.
- G** less than 50 years of age or achieved significance within the past 50 years.

**Narrative Statement of Significance**

(Explain the significance of the property on one or more continuation sheets.) See continuation sheets.

**9. Major Bibliographical References**

**Bibliography**

(cite the books, articles, and other sources used in preparing this form on one or more continuation sheets.) See continuation sheets.

**Previous documentation on file (NPS):**

- preliminary determination of individual listing (36 CFR 67) has been requested
- previously listed in the National Register
- previously determined eligible by the National Register
- designated a National Historic Landmark
- recorded by Historic American Buildings Survey
- recorded by Historic American Engineering Record # \_\_\_\_\_

**Areas of Significance**

(Enter categories from instructions)

A: Education and Social History

C: Architecture

**Period of Significance**

1927

**Significant Dates**

1927

**Significant Person**

(Complete if Criterion B is marked above)

**Cultural Affiliation**

N/A

**Architect/Builder**

Schmieder, Emil Henry, Engineer & Architect

H.H. Moore Inc., Builder

**Primary location of additional data**

- State Historic Preservation Office
- Other State agency
- Federal agency
- Local government
- University
- Other

Name of repository:

Bradley Beach Library

**10. Geographical Data**

**Acreage of property**     0.34 acres (100' x 148')

**UTM References**

(Place additional UTM references on a continuation sheet.)

|   |      |         |          |   |      |         |          |
|---|------|---------|----------|---|------|---------|----------|
| 1 | 18   | 583730  | 4450465  | 3 |      |         |          |
|   | Zone | Easting | Northing |   | Zone | Easting | Northing |
| 2 |      |         |          | 4 |      |         |          |

See continuation sheet

**Verbal Boundary Description**

(Describe the boundaries of the property on a continuation sheet.) See continuation sheet.

**Boundary Justification**

(Explain why the boundaries were selected on a continuation sheet.) See continuation sheet.

**11. Form Prepared By**

name/title     Lisa Soderberg, Historian/Annabelle Radcliffe-Trenner, Principal

organization     Historic Building Architects, LLC     date     April 2013

street & number     312 West State Street     telephone     609-393-3999

city or town     Trenton     state     NJ     zip code     08618

**Additional Documentation**

Submit the following items with the completed form:

**Continuation Sheets**

**Maps**

A **USGS map** (7.5 or 15 minute series) indicating the property's location.

A **Sketch map** for historic districts and properties having large acreage or numerous resources.

**Photographs**

Representative **black and white photographs** of the property. See continuation sheet.

**Additional items**

(Check with the SHPO or FPO for any additional items)

**Property Owner**

(Complete this item at the request of the SHPO or FPO.)

name     Borough of Bradley Beach     Attention: Janet Torsney, Director, Bradley Beach Library

street & number     710 Main Street     telephone     732-776-2999

city or town     Bradley Beach     state     NJ     zip code     07720

**Paperwork Reduction Act Statement:** This information is being collected for applications to the National Register of Historic Places to nominate properties for listing or determine eligibility for listing, to list properties and to amend existing listings. Response to this request is required to obtain a benefit in accordance with the National Historic Preservation Act, as amended (16 U.S.C.470 *et seq.*)

**Estimated Burden Statement:** Public reporting burden for this form is estimated to average 18.1 hours per response including time for reviewing instructions, gathering and maintaining data and completing and reviewing the form. Direct comments regarding this burden estimate or any aspect of this form to the Chief, Administrative Services Division, National Park Service, P.O. Box 37127, Washington, DC 20013-7127; and the Office of Management and Budget, Paperwork Reductions Projects (1024-0018), Washington, DC 20503.

United States Department of the Interior  
National Park Service

National Register of Historic Places  
Continuation Sheet

Bradley Beach Free Public Library  
Monmouth County, NJ

Section number 7 Page 1

---

**Summary: General Description**

Built in 1927 in the Classical Revival style, the Bradley Beach Free Public Library is a one-story masonry building with a nearly square (49' x 51') footprint. The building consists of a shallow hipped roof covered with green interlocking clay Ludowici tiles. The main body of the building is constructed of red brick laid in a common bond pattern with brick corner quoins, while the partially-above grade basement level, window sills, belt courses and front portico are constructed of Indiana limestone. Monumental masonry stairs rise to the main entrance. The stairs are granite with limestone cheek walls. The center entrance features original, metal-covered double doors topped with a semi-elliptical transom filled with leaded glass tracery. The doors are flanked on each side by a small octagonal, fixed-sash window and two six-over-six double-hung sash windows; the side and rear elevations are six bays deep with six-over-six double-hung sash windows. An original, full-height, front porch with a pediment supported by fluted Ionic columns and Doric pilasters shelters the entrance. The library interior consists of two floors: the first floor and a basement with an uninhabitable attic. Typical of many small libraries of this period, the first floor serves as the Main Reading Room, the prominent public space. It was designed and continues to be a wide-open space with few walls or partitions. The library stands on a .34-acre lot located at the southeast corner of Fourth and Hammond avenues; it faces north onto Fourth Avenue. The library is situated in a residential neighborhood in the southwest section of the Borough of Bradley Beach (Monmouth County, New Jersey), which is a small resort community on the central Atlantic shore of New Jersey. Neighboring buildings are single-family homes that were constructed, for the most part, between 1910 and 1940 and include buildings in the Bungalow/Craftsman, Colonial Revival, Shingle and Queen Anne styles of architecture (Photograph 2). The library is located across the street from a wood frame Episcopal Church constructed in 1917. Located only a block from the Bradley Beach Elementary School, the building is within walking distance from anywhere in the beachfront community.

**Site**

The library is bounded on the north side by Fourth Avenue on the west side by Hammond Avenue and on the east and south sides by adjoining residential properties. The library is set back from the property line parallel to Fourth Avenue by 40'-1", and it is setback from the property line parallel to Hammond Avenue by 29'-7". It is setback from the adjoining property on the east side by 21'-7". The surrounding lot consists of lawn and mature trees. The brick walkways are lined with garden beds.

**Exterior**

**General Description**

The Bradley Beach Library is a one-story building over a partially exposed basement. Typical of a Classical Revival Style Building, the Bradley Beach Library is constructed of masonry (brick accented with limestone) and is a formal, symmetrical design with a central door and an almost square footprint (49' x 51'). Consistent with the Classical Revival Style, popular between 1895-1950, the arrangement of windows and doors at the Bradley Beach Library is symmetrical. The front of the building consists of a full height portico with a classical limestone pediment supported by two pairs of fluted Ionic columns and Doric pilasters (Photograph 10), and is flanked on each side by two bays of windows (Photographs 1 and 3). The secondary elevations on the sides and rear of the building are each composed of six bays with six-over-six double hung sash windows (Photographs 4-7).

The limestone pediment above the brass entrance doors is adorned with classical details. There are block modillions at both the raking and horizontal cornices. The tympanum at the center of the pediment is adorned with a carving of an open book framed with a cartouche (Photograph 8). Monumental granite steps provide access to the center entrance. The building is brick with a limestone foundation / watertable, limestone sills, window surrounds, belt courses and coping stones. The limestone water table extends above the basement windows, providing a bold horizontal band at the base of the building. The building's brick pattern is running bond, which consists entirely of stretcher courses. There are brick quoins at each of the four corners of the building with a quoin flanking each side of the portico at the front of the building (Photograph 9). The limestone belt course above the windows is accentuated by a brick soldier course directly under the

United States Department of the Interior  
National Park Service  
**National Register of Historic Places**  
**Continuation Sheet**

**Bradley Beach Free Public Library**  
**Monmouth County, NJ**

Section number 7 Page 2

---

limestone units. This belt course pattern extends around the perimeter of the building. A brick parapet wall rises above the brick and limestone belt course and is capped with a limestone coping stone. There are brick recessed panels in the parapet wall, which are each located above a window, emphasizing the verticality of the large window openings. The original windows have been replaced recently with six-over-six light double-hung aluminum-clad wood windows. The new window sashes have been set into the original wood frames, which have been capped with new casings. A new aluminum sill was installed to accommodate the new replacement windows.

***Roof***

The brick and limestone building walls are enclosed with a shallow-hipped roof, clad with interlocking green clay Ludowici tiles. The tiles are not original, but were fabricated by the original roof tile company and closely resemble the original tiles in color, shape and form. The hip roof terminates directly behind the parapet wall, which makes the roof form appear even shallower. The top of the roof is flat and covered with an EPDM membrane. The flat portion of the roof is rimmed with a profiled copper molding, which caps the tile roof (Photographs 4, 5 and 11). At the base of the tile roof directly behind the parapet wall is a built-in gutter, lined with a single-ply EPDM membrane. The water in the gutters drain to decorative metal scupper boxes at the corners of the building, where the water flows into metal downspouts that terminate into PVC piping, which conducts the water away from the building. A standing seam copper roof caps the limestone pediment above the entrance.

***Elevations***

*North Elevation: Fourth Avenue Elevation*

The primary elevation is the north elevation, which faces Fourth Avenue (Photographs 1 and 3) and consists of five bays with a central pediment flanked on each side by two bays of windows. The monumental classical detailing of the Library entrance way includes the granite steps and the full height portico with a limestone pediment at the center of the building. The pediment is supported by fluted ionic columns and Doric pilasters (Photograph 10). The raking and horizontal cornices are adorned with block modillions. The significance of the Library's mission in the Community is represented in the stone carving in the tympanum at the center of the pediment, which consists of an open book framed by a cartouche (Photograph 8). Wide, monumental granite steps with limestone cheek walls provide access to the main entrance. A pair of metal railings flanks the stairs with a modern additional railing at the center of the stairs (Photograph 1). The entrance features double 12-foot high wood doors that are covered with brass and metal alloy plating (Photograph 13). There is a decorative fanlight with the original lead tracery above the entry doors. The frame of the fan light is also clad with the same metal alloy plating that covers the doors. The doors are framed on each side by small octagonal wood framed original windows with limestone surrounds (Photograph 12).

*West (Side) Elevation: Hammond Avenue Elevation*

The West elevation is the secondary elevation that faces Hammond Avenue (Photograph 5). This elevation consists of six bays evenly spaced across the elevation. The small basement windows align with the large first floor windows. Decorative metal scupper boxes connected to downspouts are located at each corner of this elevation.

*East (Side) Elevation*

The East Elevation is identical to the West Elevation (Photographs 6 and 7). A small freestanding outbuilding with a gable roof has been installed perpendicular to the East Elevation. (Refer to description under non-contributing resources). The outbuilding abuts the exterior masonry wall, but the original wall has not been penetrated.

*South (Rear) Elevation*

The South or rear elevation faces the rear yard. It consists of six bays that are grouped in three pairs (Photograph 5). As in the other elevations, the basement windows align with the large first floor windows. The pair of windows on the east side of the elevation flanks a brick chimney. A small entrance to the basement spaces, which is original, is located

United States Department of the Interior  
National Park Service  
**National Register of Historic Places**  
**Continuation Sheet**

**Bradley Beach Free Public Library**  
**Monmouth County, NJ**

Section number 7 Page 3

---

beneath the center pair of windows (Photograph 14). The rear entry is constructed of limestone walls with a metal clad door with six lights. There is a metal cover on the east side of the rear entry. This covers an area in the basement, which was used originally to receive coal for the boiler.

**Interior**

The Library interior consists of two floors: a partially exposed basement and the Main Reading Room on the first floor.

***Basement***

The spaces in the basement are organized around a small circulation corridor, which is located on the north side in the center of the building. The largest room in the basement is the Children's Library (30'-3" x 31'-0"), which is located in the southwest corner of the building (Photograph 31). The east and south sides of the Children's Library receive natural light through the basement windows. On the south side of the room, steps lead to an "exit" door. A Meeting Room and the Boiler Room are adjacent to the Children's Room on the east side of the building. The Meeting Room is 16'-1" x 22'-4", while the Boiler Room is 15'-7" x 8'-10". On the west side of the circulation corridor is the Staff Office or reference area (14'-11" x 16'-7 1/2") (Photograph 32), while the Staff Lounge (14'-11" x 16'-8") is on the east side of the circulation corridor (Photograph 30). A barrier free restroom has recently been installed on the east side of the circulation corridor as shown on the plan. The restroom has no window and consists of blue tile and contemporary barrier free fixtures (Photograph 33).

The original basement finishes are simple, consisting of plaster walls and ceilings with wood trim and baseboards. For the most part, the plaster walls and original trim remain intact. The original dumbwaiter, which transported books from the first floor to the basement, remains intact (Photograph 21). Some of the wood baseboards have been covered with a new contemporary baseboard. Many of the single-paneled metal basement doors are original and retain their original hardware. The coal conveyance mechanism remains intact in the boiler room (Photograph 34).

***First Floor***

Typical of many small libraries of this period, the first floor serves as the Main Reading, the prominent public space. The first floor remains as it was originally designed: a large open space (46'-4 1/2" x 48'-10") with few walls or partitions, and illuminated with natural light on all four sides through large double-hung windows. It remains the Main Reading Room and consists of the circulation desk, reading areas, main stacks, and a public computer area (Photographs 19, 23, and 25). The circulation space is located on the north side at the center of the building. It consists of a small entry vestibule (5'-9" x 7'-0") (Photograph 17); the stairs to the basement are located next to the vestibule on the west side (Photograph 24), while a staff bathroom with its original tile floor is located on the east side of the vestibule (Photograph 22). The vestibule, stair and bathroom represent the only enclosed spaces on the first floor.

The finishes in the Main Reading Room include plaster walls and dark green marble baseboards (Photograph 28). A suspended ceiling with fluorescent lighting conceals the original coffered plaster ceiling with ornamental plaster detailing. The original ceiling remains intact, though there has been some water damage to the plaster related to the deterioration of the roofing and rainwater conductor system (Photograph 29). The majority of the original wood furniture remains in use including the circulation desk and the bookcases (Photographs 16, 20, 23, 25, 26). The original cork floor with a perimeter fret pattern remains intact. (Photograph 27). However, in 2012, the original floor was covered with carpet to prevent further deterioration to the historic fabric. The finishes in the entry vestibule are original and consist of white and light green marble edged with dark green marble. The door from the vestibule to the Main Reading Room is also original and consists of sidelights, capped with a semi-elliptical transom with leaded glass tracery (Photograph 15).

There are two commemorative bronze plaques in the entry vestibule, which are also original to the building. One plaque identifies and celebrates the individuals, who played an instrumental role in the founding and construction of the library

United States Department of the Interior  
National Park Service  
**National Register of Historic Places**  
**Continuation Sheet**

**Bradley Beach Free Public Library**  
**Monmouth County, NJ**

Section number 7 Page 4

---

(Photograph 18):

“The Bradley Beach Free Public Library  
Erected 1927  
Founded by the Women of Bradley Beach  
On land Given by the Hon. James A. Bradley  
Building Erected by the Borough.”

The second plaque memorializes those individuals from Bradley Beach, who lost their lives during World War I.

### **Non-Contributing Resources**

#### ***Outbuilding: Storage Shed***

A prefabricated storage shed has been installed perpendicular to the East elevation. The west wall of the storage shed is approximately 8 inches from the library-building wall. The shed consists of vinyl siding and an asphalt shingle roof. On the north elevation there are a pair of doors and a single double-hung vinyl window with snap-in muntins. The shed is a non-contributing building. It does not adversely impact the architectural character of the library building, because it is a temporary building, which can be removed easily without damaging the historic library (Photographs 6 and 7).

#### ***Garden Sculpture***

A modern bronze sculpture of a young girl lying down reading a book is located under a tree at the front of the library. This modern sculpture is non-contributing and does not adversely impact the architectural character of the library building (Photograph 1).

### **Building Evolution and Modifications**

The original footprint of the building has not been modified. However, there have been a few physical modifications to the building since its original construction. For the most part the building remains intact as it was originally constructed.

#### ***Exterior Modifications***

##### ***Window Replacement***

The most significant modification to the building exterior includes the replacement of the original wood six-over-six double-hung sash windows with an aluminum clad double-hung sash window in 2010-2011. The replacement sashes were set into the original wood frames, which have been covered with a new casing. New aluminum sills were installed to accommodate the new windows. The masonry opening was not modified when the replacement windows were installed.

##### ***Modifications to Front Stair***

Historic photographs depict a wide stone landing at the base of the entry stairs flanked by tall limestone urns, which emphasize the monumentality of the entry sequence (Figure 2). The original wide stone landing has been removed or covered and the urns have been lost. Originally, there was only a pair of metal railings flanking the stairs. An additional metal railing was recently installed at the center of the stairs (Photograph 1).

##### ***Roof Replacement***

The original Ludowici interlocking green clay tile roof was replaced in 2010 with a tile that was fabricated by the original manufacturer and closely resembles the color, shape and form of the original tile. The original copper sheet metal gutter lining and roof flashing was replaced in 2006. In 2009-2010, a single-ply EPDM roof membrane was installed at the gutters.



United States Department of the Interior  
National Park Service  
**National Register of Historic Places**  
**Continuation Sheet**

**Bradley Beach Free Public Library**  
**Monmouth County, NJ**

Section number 7 Page 5

---

***Interior Modifications***

Originally the double-height Main Reading Room consisted of a coffered ornamental plaster ceiling. Historic photographs show the original ornamental ceiling with the original light fixtures (Figure 4). Sometime during the 1960s or 1970s, a drop ceiling and fluorescent lighting was installed in the Main Reading Room. Although there is evidence of some water damage related to a leaking roof, the original plaster ceiling remains intact above the modern drop ceiling (Photograph 29).

There is a large room in the basement at the south side of the building, which was originally a Lecture Hall or Community Room, and now serves as the Children's Room. Originally, the Children's Room was located on the first floor. It was moved to its present location sometime during the mid-twentieth century. Minor changes have been made to the basement to accommodate a barrier free restroom. Essentially, the footprint and layout of the building remains intact.

In 2012 carpeting was installed in the Main Reading Room, covering the original cork flooring.

***Chronology of Modifications and Maintenance Procedures***

*Below is a summary of the documented modifications made to the building since its construction:*

**1960s-1970s:** Installation of drop ceiling and fluorescent lighting in the Main Reading Room; the Children's Section was moved from its original location on the first floor to a large room in the Basement.

**1989:** Exterior Waterproofing by Leon S. Avakian, Inc. Neptune, NJ. We believe that a coating may have been applied to the masonry walls at this time. Further investigation is required to ensure that the coating is not damaging the existing brick.

**2001:** The metal clad front entrance doors were restored.

**2002 and 2005:** Goodrich Plastering (Oakhurst) repaired the plaster ceiling in the basement.

**2005:** Barrier-free restroom installed in the basement to increase accessibility to and within the library.

**2006:** Roof Rehabilitation Project replaced the built-in gutter lining and scuppers. These initial rainwater conductor repairs did not eliminate the water infiltration and leaks.

**2006:** The marble and granite entrance was cleaned by Marblelife (Manalapan).

**2009-2010:** The clay tile roof and roof membrane were replaced with new Ludowici tile and a single-ply EPDM membrane.

**2010:** The original boiler was replaced and the oil tank was removed.

**2010-2011:** The original wood six-over-six double-hung windows were replaced with six-over-six aluminum clad wood double-hung windows.

**2012:** Carpeting was installed in the Main Reading Room covering the original cork floor.

**Integrity**

The library remains in good condition and retains a high degree of integrity, particularly its interior features including original furnishings and finishes, which all remain intact. The footprint of the original library structure remains intact without any modifications.

United States Department of the Interior  
National Park Service  
**National Register of Historic Places**  
**Continuation Sheet**

**Bradley Beach Free Public Library**  
**Monmouth County, NJ**

Section number 8 Page 1

**Summary Statement of Significance**

Constructed in 1927 as a Free Public Library, the Bradley Beach Library embodies the civic efforts of the Woman's Improvement League (WIL), a local woman's club, which established the library to provide educational enrichment to the citizens of Bradley Beach. The civic efforts of the women of Bradley Beach during the early 20<sup>th</sup>-century reflect the initiatives of women's voluntary organizations throughout the country and the State of New Jersey to influence the development of their communities, promoting cultural, educational, religious and social reforms. Although the Bradley Beach Free Public Library was constructed after the Carnegie Foundation discontinued the construction of local libraries, the design of the Bradley Beach Library followed many of the design guidelines and innovations recommended by Andrew Carnegie and James Bertram, Carnegie's personal secretary. The Bradley Beach Library is locally significant as a representative example of the instrumental role women's clubs and women's civic, cultural, and social volunteer organizations played in spearheading successful local library campaigns in hundreds of communities throughout the country during the first quarter of the 20<sup>th</sup>-century. The Library is also significant as a representative example of early 20<sup>th</sup> century library design, embracing the ideals of the "Free Library Movement," which were reflected in Andrew Carnegie's reforms of American library architecture. The period of significance of the Library is 1927, the year the building was constructed.

**Historical Background**

Bradley Beach is a popular summer resort situated on the Atlantic Ocean, with a mile and a half of "perfect beach-front." The town originated in the 1870s when huge tracts of land were purchased for suburban development by James A. Bradley. Mr. Bradley made his fortune at Bradley & Smith, a brush manufacturing company, which ranked among the largest in the country. James A. Bradley, a philanthropist and developer, founded several resort communities along the New Jersey Coast, also including nearby Asbury Park and Ocean Grove.<sup>1</sup>

In the stretch of dense underbrush, pine forests and sand dunes that he acquired, Mr. Bradley saw the possibility of a thriving summer resort and subsequently laid the foundations for the community of Bradley Beach, building roads, constructing homes and a brick board-walk along the beach front. Often Mr. Bradley would sell the building lots cheaply, on the condition that the owner erects a building of good quality. He envisioned Bradley Beach as "the City Beautiful" with broad avenues, which remain-in-place today.<sup>2</sup>

In 1912 when a new railroad station was constructed in Bradley Beach, serving the New York and Long Branch Railroad, Bradley Beach became a destination for people from the northern urban areas of New Jersey and New York City. By 1913, only two decades after the town was incorporated, Bradley Beach was distinguished as the fastest growing Borough on the Jersey coast and had a significant, year-round residential community. The 1913 souvenir booklet boasted that Bradley Beach is "equipped with every modern convenience known to the larger cities," including an up-to-date sewer system, a first class artesian water system, and gas and electric lights. "Persons desiring to live in a community having all of the conveniences of city life and at the same time being away from the city, will find an ideal home town in Bradley Beach."<sup>3</sup> It was stated that "Bradley Beach property always brings good returns whether the property be rented or sold. Much money is being made by small investors as well as large ones."<sup>4</sup>

<sup>1</sup> "Jas A. Bradley dies; founder of Asbury," *The New York Times*, June 7, 1921.

<sup>2</sup> Frank Scott York, "The Honorable James A. Bradley," *75<sup>th</sup> Diamond Jubilee 1893-1968: Commemorative History of the Borough of Bradley Beach, NJ* (Bradley Beach: Borough of Bradley Beach, 1968), 8.

<sup>3</sup> Borough Council, *Souvenir Booklet: Bradley Beach, NJ* (Bradley Beach: JT Kinney, The Sea Coast News, 1913). The Borough published several Souvenir Booklets during the early 20<sup>th</sup>-century, which described Bradley Beach and promoted the quality of life in this resort community. There are no page numbers.

<sup>4</sup> *The Woman's Improvement League (Handbook)*, 8.

United States Department of the Interior  
National Park Service  
**National Register of Historic Places**  
**Continuation Sheet**

**Bradley Beach Free Public Library**  
**Monmouth County, NJ**

Section number 8 Page 2

---

It was within this context that a local woman's club, the Woman's Improvement League was organized in Bradley Beach in 1913. It was stated in the WIL Annual Report that the "aim and ambition of the League is the improvement of the Borough." The Secretary of the WIL, Minnie F. Van Kirk stated that "we have moved rapidly to our goal, which is that every woman interested in the moral, social and economic welfare of the Borough shall become a member of the Woman's Improvement League." The Bradley Beach WIL formed committees "to comfort the sorrowing, visit the sick and afflicted," and provide food and clothing to the needy. There was a Committee on Economics formed to make every possible effort to check the continual rise of the high cost of living. The 1913 WIL Handbook states that "there are many conditions in our Borough, which directly affect our purses and which must be remedied." There was a parent and teachers committee formed to ensure a "great cooperative movement" between parents and teachers. There were other Committees formed to address the health and hygiene of the community including the inspection of milk and drinking water. "In sum our work must be aggressive and effective to the end that Bradley Beach be known not only as the most progressive borough on the Jersey coast, but also as the most healthful." Finally, there was a WIL Library Committee formed, which established the Bradley Beach Free Public Library in 1913, the WIL's first year.<sup>5</sup>

In the following years, the WIL spearheaded important initiatives for the Library, including promoting Borough control, a town-wide referendum, and the donation of land for the library. Their commitment to establishing the Library as a permanent local institution is consistent with the work of countless voluntary women's organizations in similar small towns across the country, efforts that were critical to the success of local library campaigns of the early 20th-century.

In 1913, the Chair of the WIL Library Committee, Josephine Stiles, lamented that several neighboring resort towns had free public libraries, while Bradley Beach, which she acknowledged to be the "most progressive town along the north Jersey shore, is still without a library." Mrs. Stiles went on to say: "It is within the power of the people of Bradley Beach to create a library. The law provides that a vote may be taken at any time, and if this vote be favorable the governing body may raise by taxation a sum equal to one third of a mill on every dollar of assessable property. In other words, a house assessed at \$2,250 would be taxed seventy five cents a year. Will not every one agree that at such a cost it is easily possible for all parents to provide their children with this means of securing knowledge?"<sup>6</sup>

By the end of the year, the WIL had placed the Library in their clubhouse located in the "old school building." The Chair of the WIL Housekeeping Committee stated that through the courageous efforts of her committee, the big bare room and cheerless quarters in the old school building was transformed into a comfortable League Room. She stated that the "room is open to all and we cordially invite everyone interested in our work to visit us any afternoon and have a little chat and a cup of tea." The Library Committee Chair described the new library space in the clubhouse: "The front of the League room, with its southern exposure and many windows, has been divided into recesses by bookcases, and it is within these recesses that the future library of Bradley Beach has been born."<sup>7</sup> Typical of many of the early library ventures, the Bradley Beach Free Public Library began by securing the traveling library of fifty books sent out by the New Jersey Public Library Commission. They also circulated magazines and new and used books that they acquired by going house to house, canvassing the community for their first permanent book collection.<sup>8</sup> The book donations included Mr. James A. Bradley's donation of \$50.00 for the purchase of encyclopedias.<sup>9</sup>

The WIL of Bradley Beach worked hard to secure municipal control of the public library. They stated that it was their ambition to see a "library under municipal control" before the end of 1914, because it brought many benefits including the

---

<sup>5</sup> *The Woman's Improvement League (Annual Report)* (Bradley Beach: NJ) 1913, 8-15.

<sup>6</sup> *Ibid.*, 15.

<sup>7</sup> *Ibid.*, 7.

<sup>8</sup> From the Bradley Beach Library, Courtesy Shirley Ayres private collection; Shirley Ayres and Troy Bianchi, *Bradley Beach Post Card History Series*, (Portsmouth, NH: Arcadia Publishing, 2004), 57.

<sup>9</sup> "Bradley Beach", *Asbury Park Evening Press*, April 18, 1914.

United States Department of the Interior  
National Park Service  
**National Register of Historic Places**  
**Continuation Sheet**

**Bradley Beach Free Public Library**  
**Monmouth County, NJ**

Section number 8 Page 3

---

ability to use local taxes to fund the library.<sup>10</sup> It also facilitated the appropriation of other funding for the library. In an article in the *New York Times*, dated May 31, 1914, it appears that the women experienced a few roadblocks in their initial efforts to establish the library under municipal control:

The women of Bradley Beach, under the direction of Mrs. C. Carol Martin (member of the WIL), have taken a determined stand in municipal affairs, and already they have been in sharp conflict with some of the male officials of the town... The proposition went to the voters at a special election, and the league lost by twelve votes. It was not so much that Bradley Beach is opposed to a library, the women declare, as it is the men object to women taking the initiative.<sup>11</sup>

Undeterred the WIL continued to raise funds and operate the Library. These early fundraising efforts were small grassroots efforts spearheaded by the women, which was typical of the fundraising efforts of women's clubs. A 1914 article in *Asbury Park Evening Press* describes one of the "Tag Day" events, which raised \$315.00 for the library: "By the days end scarcely a person who had been out on the streets of the boro had failed to be approached by the women selling the tags. The purpose of the proceeds from tag day this year is to go toward the.... upbuilding (sic) of the Bradley Beach Library."<sup>12</sup> As adjacent municipalities such as Belmar in 1914 and Avon-By-The-Sea in 1916 constructed Free Public Libraries and their communities reaped the benefits, the WIL Lobby for Bradley Beach's own Public Library must have intensified. Eventually, the women prevailed, and the library came "under municipal control" by the end of 1917.<sup>13</sup> When the Borough of Bradley Beach took control of the library with its collection, it was moved to a building on the northeast corner of Brinely Avenue. In November 1917, the citizens of Bradley Beach voted to establish a free public library in accordance with Public Law P.L. 1905 p. 273. "An Act concerning free public libraries." The following month, the commissioners of the Borough of Bradley Beach appointed five citizens to the newly formed Borough Library Board in accordance with the law. Members included Miss Josephine Stiles (5-year term) and Mrs. John Van Kirk (2-year term) both active members of the WIL. These women remained on the Library Board until after completion of construction in December 1927.

On October 28<sup>th</sup> 1918, James A. Bradley, for whom the town was named, donated the land at Fourth and Hammond Avenues to the Trustees of the Free Public Library of Bradley Beach to be "used expressly for the construction of a library building."<sup>14</sup> From August 1917 the Free Public Library received financial operating support from the Borough of Bradley Beach, and by December 1917 quarterly payments were established to the Library Board. The first record of payment was \$300 in August 1917 and by 1925 this had increased to \$1,650 per annum.<sup>15</sup>

By January 1925 Mrs. Lepine, another member of the WIL was appointed to the Library Board of Trustees, and Mrs. Minnie F. Van Kirk was reappointed for a five-year term. The WIL women now had a 3 to 2 citizen membership majority on the Library Board of Trustees and were also in good favor with Mayor Frank C. Borden and the two other Commissioners Poland and Rogers. In referring to Mrs. Minnie F. Van Kirk's reappointment, Mayor Frank Borden was quoted in the *Borough Minutes* "The Board had functioned so well under the present commission, it gave him pleasure to recommend her reappointment."<sup>16</sup>

By the end of 1925 the relationship between the Borough Commissioners and Trustees of the Free Public Library was

---

<sup>10</sup> *The Woman's Improvement League (Handbook)*, 15.

<sup>11</sup> "Bradley Beach Lively", *The New York Times*, May 31, 1914.

<sup>12</sup> "Tag Day Nets Library \$315", *Asbury Park Evening Press*, August 3, 1914.

<sup>13</sup> Office of the Borough of Bradley Beach, Municipal Ordinances, September 11, 1917.

<sup>14</sup> Office of the County Clerk, County of Monmouth, Deed for Bradley Beach Library, October 28, 1918.

<sup>15</sup> Office of the Borough of Bradley Beach, Meeting Minutes 1917-1927.

<sup>16</sup> Ibid.

United States Department of the Interior  
National Park Service  
**National Register of Historic Places**  
**Continuation Sheet**

**Bradley Beach Free Public Library**  
**Monmouth County, NJ**

Section number 8 Page 4

---

cemented with the deed for the land for the new Library transferred to the Borough of Bradley Beach,<sup>17</sup> paving the way for a bond to be issued according to P.L. 1950, and in April 1926 the Borough solicitor was authorized to prepare an ordinance for the construction of the Free Public Library.<sup>18</sup>

The Bradley Beach commissioners begin discussions on a new building for the Free Public Library and on June 15, 1926, a “Motion by Poland and seconded by Rogers that the certificate from the Trustees of the Free Public Library of Bradley Beach, N.J. be received, filed and the Board of Commissioners proceed as the law directs to provide necessary money to provide the new building by the issuance of bonds to defray the cost of construction, equipment and decorating and an ordinance be prepared authorizing the issuance of bonds for such work in accordance with plans and specifications approved by the said Library Trustees.”<sup>19</sup>

In the same month the Borough Architect Emil Henry Schmieder was instructed by the Commissioners to prepare sketches for the New Pavilion and Bathing Casino Group and the new proposed Library building. Bids for the Library were advertised and on October 26, 1926 an ordinance authorizing and empowering the Trustees of the Free Public Library of Bradley Beach, NJ to expend the sum of \$50,000 for “the purpose of erecting, equipping, furnishing and decorating” the Library was approved. A bond of \$50,000 was obtained by the Borough to fund the Library construction. The Library Board were given the funds in installments, transferred into the Building account beginning with \$15,000 in February 1927, when construction was underway. The Library continued to operate and receive operating funds from the Borough during the construction of the new Library at the corner of Hammond and 4<sup>th</sup> Avenue.

By the end of 1927 construction was complete and the Bradley Beach Public Library opened. At the library opening ceremony, the Reverend Dr. Furman A. DeMaris embraced the significance of the event and emphasized the importance of the library to Bradley Beach: the library is “the heart and muscle” of a community.<sup>20</sup> In the souvenir booklet, published by the Borough a year after the Library was constructed, it stated that catering to the visitor is a “modern free library of fireproof construction,” housed in a beautiful building with over thirteen thousand volumes, all the current magazines, and “an extensive reference department where the vacationist is welcomed and shown the greatest courtesy.”<sup>21</sup>

The grassroots effort of the WIL beginning in 1913 clearly played a vital role in establishing the Free Public Library of Bradley Beach. These women used their political acumen to leverage existing State Public Library Laws to engage local government in the building of this Library. By 1919 women had the right to vote and the appointment of three WIL members to the 5 person civic Library Board of Trustee demonstrates the ability of women to embrace their new political power and use it to improve civic society with the establishment of a permanent home funded by the municipality for the Free Public Library of Bradley Beach.

### **Significance of the Bradley Beach Free Public Library**

#### ***Evaluation under National Register Criterion A***

The Bradley Beach Free Public Library is significant as a well-preserved example of an early 20th-Century public library, which was established by a local woman’s club. The women’s clubs were instrumental to the success of library campaigns in hundreds of communities across the country because women were unflinchingly convinced of the benefits of a public library and often sustained interest in the project long after others became disenchanted or frustrated.<sup>22</sup> The Bradley Beach Free Public Library embodies the civic efforts of the Bradley Beach WIL to create a public library, providing a space for

---

<sup>17</sup> Office of the County Clerk, County of Monmouth, Deed for Bradley Beach Library, December 7, 1925.

<sup>18</sup> Office of the Borough of Bradley Beach, Meeting Minutes 1917-1927.

<sup>19</sup> Ibid.

<sup>20</sup> “Bradley Beach Library Dedicated”, *Asbury Park Evening Press*, December 2, 1927.

<sup>21</sup> Borough Council, *Souvenir Booklet*, (Bradley Beach: Borough of Bradley Beach, 1928).

<sup>22</sup> Theodore Jones, *Carnegie Libraries Across America: A Public Legacy* (New York: John Wiley & Sons, Inc.), 42.

United States Department of the Interior  
National Park Service  
**National Register of Historic Places**  
**Continuation Sheet**

**Bradley Beach Free Public Library**  
**Monmouth County, NJ**

Section number 8 Page 5

---

the cultural and educational needs of the community.

*The Role of Women's Clubs in the Development of Public Libraries*

In the *National Register Nomination of Clubhouses of NJ Women's Clubs*, the authors refer to the period from the 1880s through the mid-1920s as the age of voluntary organizing for women, one of the most active periods of growth and engagement for women's clubs. The organization of the women's suffrage movement may have contributed to the formation and growth of women's clubs. "By the beginning of the 10<sup>th</sup> Century the movement had gained in scope and momentum. Clubs served to meet the pressing needs of the women of the day and became the vehicle for independence and self-determination -- a way of earning women the right to an education, the right to work, the right to manage finances, the right to own property and to vote. The vision and dedication of the founders of the Women's Club movement places them among the early crusaders for women's rights."<sup>23</sup> This argument holds because as domestic burdens diminished from inside women home they could focus on the world and joined Women's Clubs to become powerful, social reformers. By the turn of the 20<sup>th</sup>- century, millions of women were members of clubs. As these women's clubs flourished, they provided a previously unknown outlet for middle-and upper-class women to exercise their organizational and leadership skills.<sup>24</sup>

During this period, the availability of factory-made household goods and labor-saving devices at home began to produce leisure time in the lives of women in the developing middle class that they used to pursue what was commonly called "self-culture." Early clubs usually were comprised of ladies with interests in common. Typically programs were literary in character, designed to educate and cultivate self-improvement. Simultaneously, a more systematic and intentional development was occurring along the East Coast that eventually led to the formation of the General Federation of Women's Clubs (GFWC), a national organization that embraced a wide variety of political and social causes, advocating for civic improvement and social change. In time this federation would embrace the small women's clubs that were proliferating nationwide, and give focus and drive to their individual efforts. The General Federation of Women's Clubs held its first biennial meeting in 1890. By the third biennial meeting in 1896, the federation was beginning to move from a focus on its own structure and procedures to an action agenda for improvements in society. Libraries were an early and prominent item on this "action agenda."<sup>25</sup>

Meanwhile, the evolution from a focus on self-improvement to civic improvement was also occurring in women's clubs on the local level. The women's clubs seemed to share "some inner dynamic" that led them to acknowledge that they had done enough for themselves and now owed something to the larger community. Libraries were among the very earliest objects of women clubs' focus in advocating for civic improvement and community development.<sup>26</sup>

The period between 1870 and 1930 was a period of very rapid growth in the number of free public libraries in the United States. Women's clubs contributed in a very tangible way to the spread of the public library idea and the foundation of numerous libraries in cities and towns across the country. In 1914, the executive secretary of the American Library Association, G.B. Utley, stated that "fully one half the libraries in the country had been established through the influence of American women." In 1933, Sophonisba Breckenridge, writing as a contributor to a presidential commission report on social trends in the United States, reported that the American Library Association credited "women's clubs with the responsibility for initiating seventy-five percent of the public libraries now in existence in the United States."<sup>27</sup> The establishment of the Bradley Beach Free Public Library by the WIL was an integral part of this nationwide movement and embodies the significant and widespread role that the women's clubs played in establishing libraries throughout the

---

<sup>23</sup> NJSFWC, *A Century of Challenge: New Jersey State Federation of Women's Clubs First 100 Years*, (New Brunswick: NJSFWC, 1994) 4.

<sup>24</sup> Ellen Freedman Shultz and Deborah Marquis Kelly, *National Register Nomination of Clubhouses of NJ Women's Clubs MPDF*, Section E,1-3.

<sup>25</sup> Paula D. Watson, "Founding Mothers: The Contribution of Women's Organizations to Public Library Development in the United States", *Library Quarterly*, Vol. 64, Issue 3, 1994, 233-236.

<sup>26</sup> *Ibid.*, 233-236.

<sup>27</sup> Quoted in *Ibid.*, 234-236.

United States Department of the Interior  
National Park Service  
**National Register of Historic Places**  
**Continuation Sheet**

**Bradley Beach Free Public Library**  
**Monmouth County, NJ**

Section number 8 Page 6

---

country.

*New Jersey State Federation of Women's Clubs*

After the General Federation of Women's Club's was established, the state federations began to form. The New Jersey State Federation of Women's Clubs (NJSFWC) was founded in 1894, only a few years after the General Federation. The Bradley Beach WIL was a member of the NJSFWC, which encouraged the women's clubs to promote and establish libraries. One of the five initial departments in the NJSFWC's was "Libraries." The Federation was instrumental in putting together legislation for a state commission to promote traveling libraries to circulate knowledge within local communities. Typical of many early libraries, the Bradley Beach Free Public Library made use of the Federation's traveling library before it acquired its own permanent collection. The efforts of the WIL in establishing the Bradley Beach Free Public Library were applauded by the NJSFWC. In *A Century of Challenge: New Jersey State Federation of Women's Clubs, First 100 years*, the NJSFWC states that they are "very proud that a high percentage of the local libraries in New Jersey were organized through the efforts of women's clubs."<sup>28</sup>

The *New Jersey Women's Heritage Trail*, a survey of *New Jersey Women's Historic Sites*, (300 historic sites surveyed) identified three libraries that were started by women. [The *New Jersey Women's Historic Sites* project identified several additional library buildings organized by women, but these properties were not included in the survey stage of the project.] The libraries identified in the survey include the Newfield Library in Newfield, Gloucester County, which was organized by a woman's organization as early as 1860 and is now the headquarters of the Newfield Historical Society; the Haddonfield Public Library in Haddonfield, which was founded in 1917 by Julia Bedford Gill; and the Pease Library in Ridgewood, Bergen County founded in 1921-23 by Geraldine Pease Anderson.

*The Rapid Growth of Libraries in New Jersey*

The rapid growth in libraries in New Jersey in the first quarter of the 20<sup>th</sup> century was in large part due to Miss Sarah Byrd Askew, the New Jersey Public Library Commission secretary appointed in 1905. The number of libraries in NJ increased by 246 during her term as secretary. She was a woman of "great personal charm and intelligence, she was also a gifted public speaker, whose skill in persuading public bodies to establish and support libraries was unrivalled."<sup>29</sup> She used her southern charm and gained the support of the PTA, the State Federation of Women's Clubs, the State Readers Associations, and local grange groups in her quest to develop new libraries. This may well explain why so many libraries were formed through the influence of women run movements in New Jersey.<sup>30</sup>

The association between the WIL and the establishment of the Bradley Beach Free Public Library represents a typical pattern in the development of public libraries in the early part of the 20<sup>th</sup>-Century: from the beginnings of the small library in a single room in the women's club, to the club's active involvement in garnering public support for the library, to their vision to push for municipal control of the library, and finally to their tireless efforts to raise money for the erection of a library building through small-scale grass roots fund-raising events.

The establishment of the Bradley Beach Public Library by the WIL was part of the larger movement of women's voluntary organizations, which devoted their efforts to cultural, educational, religious and civic reforms. In an Open Letter to the Bradley Beach WIL, Mrs. S. P. Martin, a member of the League, stated that the WIL came into existence to address the needs of the community. "The rapid growth of Bradley Beach has created many problems," and as time moves on the more complex the problems will become. She continued: "A large percentage of these problems concern the home directly, and therefore they are matters for the women of the Borough, not only for the all year residents, but

---

<sup>28</sup> NJSFWC, *A Century of Challenge: New Jersey State Federation of Women's Clubs First 100 Years*, (New Brunswick: NJSFWC, 1994) 471.

<sup>29</sup> Roger McDonough, *A History of New Jersey Libraries 1750-1996*, (The Scarecrow Press, Inc Lanham, Md., & London 1997) 13.

<sup>30</sup> Barbaranne M. Warner, "Sarah Byrd Askew," October, 2003, (<http://www.webspanner.com/users/sarahaskew>)

United States Department of the Interior  
National Park Service  
**National Register of Historic Places**  
**Continuation Sheet**

**Bradley Beach Free Public Library**  
**Monmouth County, NJ**

Section number 8 Page 7

---

also for the summer residents.”<sup>31</sup>

Involvement in the welfare of the community was for many women a natural extension of family concerns. Many women believed that when they were advocating for civic improvement and social change, they were taking care of the “municipal housekeeping” of their community. In the *Survey of New Jersey Women’s Historic Sites*, prepared by Preservation Partners, they state: “Collectively and individually, women community builders addressed public needs when government was slow to act, initiating social services, founding institutions to serve the sick, disabled, and needy, and pressing for libraries, improved education, and better health care.”<sup>32</sup> The Bradley Beach Free Public Library is locally significant because it embodies the efforts of these early 20th-Century women’s voluntary organizations committed to education and literacy, and devoted to improving the welfare and conditions of their communities.

***Evaluation under National Register Criterion C***

The Bradley Beach Free Public Library is also significant as a representative example of early 20th-Century library design, which embraced the ideals of the “Free Library Movement and the “Modern Library Idea,” both of which were reflected in Andrew Carnegie’s reforms of American library architecture.

The neighboring resort communities of Avon-by-the-Sea and Belmar, which built libraries more than ten years before Bradley Beach, received funds from the Carnegie Corporation to construct their public libraries. By the time Bradley Beach was ready to build their public library, the Carnegie Corporation was funding library education rather than buildings. However, the Bradley Beach Free Public Library was constructed at the peak of public library construction in the United States. In the 1922-1923 Annual Report of the Public Library Commission of the State of New Jersey, issued only a few years before the Bradley Beach Free Public Library was constructed, stated:

In spite of the cry of high taxes more New Jersey municipalities last year voted to give tax support to libraries than have ever voted in one year, and this was in addition to the county and township libraries established by popular vote. Local library appropriations have more than doubled in the past three years, and during the period covered by this report more library buildings have been constructed in this state than ever before in one year, although the Carnegie Foundation has discontinued giving money for this purpose.<sup>33</sup>

The design of the Bradley Beach Free Public Library was profoundly influenced by Carnegie’s reforms of American library architecture despite the absence of Carnegie funds. In 1911, Carnegie and his Secretary, James Bertram, published a pamphlet, “Notes on the Erection of Library Buildings” [sic], which included six floor plans for small library buildings. After the publication of the pamphlet, small town libraries, whether funded by the Carnegie Foundation or not, tended to be modest, utilitarian structures in the Carnegie Classical style. The pamphlet was remarkably effective in promoting the open-plan library, with its centrally located circulation desk and flanking reading rooms as the ideal for small public libraries.<sup>34</sup>

Carnegie’s architectural reforms coincided with fundamental changes in the basic philosophy of library administration and planning. The traditional vision of the library as a treasure house, where the library shelves were closed to the patrons,

---

<sup>31</sup> *The Women’s Improvement League (Handbook)* 7.

<sup>32</sup> Ellen Freedman Schultz and Deborah Marquis Kelly, *New Jersey Women’s Historic Sites Survey Final Report* (Trenton: New Jersey State Historic Preservation Office and the Alice Paul Centennial Foundation, February 7, 2003), 29 and 59.

<sup>33</sup> Roger McDonough. *A History of New Jersey Libraries 1750-1996*. (The Scarecrow Press, Inc., Lanham, Md., & London 1997). 13.

<sup>34</sup> James Bertram, *Notes on the Erection of Library Buildings* (sic), version 3, C. 1915 as quoted in Abigail A. Van Slyck, *Free to All Carnegie Libraries and American Culture 1890-1920*, (Chicago: The University of Chicago Press, 1995), 221-222.



United States Department of the Interior  
National Park Service  
**National Register of Historic Places**  
**Continuation Sheet**

**Bradley Beach Free Public Library**  
**Monmouth County, NJ**

Section number 8 Page 8

---

who had no direct access to the books, was falling out of favor. The patrons were no longer viewed as untrustworthy readers.<sup>35</sup> Increasingly, the library profession sought to use the public library to bring readers and books together, providing the readers with direct access to the books. According to librarian, Arthur E. Bostwick, “the modern library idea” was characterized by public support, open shelves, work with children, cooperation with schools, branch libraries, and traveling libraries.<sup>36</sup> The “modern library idea” and the collective wisdom of progressive library planning was expressed in Andrew Carnegie’s design guidelines outlined in the pamphlet, “Notes on the Erection of Library Buildings.” [sic]

The “Notes” consisted of both text and recommended plans, which were diagrammatic in nature and gave no indication of wall thickness or window placement. Variations in the plans addressed differences in the size, configuration and siting of the library, (Figure 6). Plans A and B represented Bertram’s ideal library form and consisted of a simple rectangular building with a central entrance on the long side. Plan C, which most closely resembles the plan of the Bradley Beach Public Library, was meant to accommodate a site that was deeper than it was wide, which is consistent with the Bradley Beach site. Despite the differences in the plans, each followed Carnegie and Bertram’s library planning idea - small libraries should be planned so that one librarian could “oversee the entire library from a central position.” One of the focal points of the Bradley Beach Library is the original circulation desk, which is located in its original central position, directly across from the entry vestibule, where the librarian can oversee the entire library.<sup>37</sup>

The Bradley Beach Library shared many of the features that Bertram used to describe the ideal Carnegie Library. Bertram’s ideal was a one-story, rectangular building with a basement and a small vestibule leading directly into a single large room. He believed that if it was necessary to subdivide the room, low bookcases should be used as the partitions to supplement the bookcases around the perimeter of the building’s, housing the library’s collection, and providing the public open access to all books. In addition to book storage, Bertram’s “Main Reading Room” provided comfortable reading areas for both adults and children. In Bertram’s ideal library, the basement consisted of a large lecture room to accommodate community events, a heating plant, and all of the conveniences for the library patrons and staff. The design guidelines also suggested ceiling heights (nine to ten feet in the basement, twelve to fifteen feet on the first floor), and stated that the windows should be placed six feet above the floor to allow for shelving beneath.<sup>38</sup>

The design of the one-story Bradley Beach Free Public Library embraces the design goals of the small public library set forth in the pamphlet. Bertram and Carnegie believed in an open plan, which is expressed in the expansive main reading room of the Bradley Beach Free Public Library, where historic photographs indicate that the original book shelves were located around the perimeter of the room, and accessible to the patrons (Figure 4). Although the windows in the first floor reading room of the Bradley Beach Free Public Library were not set six feet above the floor as suggested in the design guidelines, they were set approximately four feet above the floor to provide space for continuous perimeter shelves. The ceiling heights specified in the guidelines were used in the Bradley Beach Free Public Library both in the basement and first floor. Characteristic of Carnegie’s recommended plans, the open reading room was subdivided into smaller adult and children’s reading rooms using bookcases as partitions. The furniture, which remains extant, became part of the architecture. The Bradley Beach Free Public Library embraced Carnegie’s vision of the economical layout of a library building with a small entry vestibule, restroom and stairs. Carnegie cautioned that space should not be wasted in the “entrance feature.”<sup>39</sup> Typical of Carnegie’s vision for the small library, a special area on the first floor was originally

---

<sup>35</sup> Abigail A. Van Slyck, *Free to All: Carnegie Libraries and American Culture 1890-1920*, (Chicago: The University of Chicago Press, 1995), 13 and 25.

<sup>36</sup> Arthur E. Bostwick, *The American Public Library*, 1910, 8-9 as quoted in Abigail A. Van Slyck, *Free to All: Carnegie Libraries and American Culture 1890-1920* (Chicago: The University of Chicago Press, 1995), 25.

<sup>37</sup> James Bertram, *Notes on the Erection of Library Buildings* (sic), version 3, C. 1915 as quoted in Abigail A. Van Slyck, *Free to All Carnegie Libraries and American Culture 1890-1920*, (Chicago: The University of Chicago Press, 1995), 221-222.

<sup>38</sup> *Ibid.*, 221-222.

<sup>39</sup> *Ibid.*, 223.

United States Department of the Interior  
National Park Service  
**National Register of Historic Places**  
**Continuation Sheet**

**Bradley Beach Free Public Library**  
**Monmouth County, NJ**

Section number 8 Page 9

---

designated for children, and lecture rooms and community spaces were accommodated in the basement of the Bradley Beach Free Public Library. Sometime during the mid-20th-Century, the Children's Reading Room was moved to the basement (Photograph 31).

Other characteristic features of the small Carnegie Library, which were shared by the Bradley Beach Free Public Library, were the masonry or brick construction and the plaster walls and ceilings with wood furnishings, including the book shelves and the librarian's desk, which remain intact today. The original plaster coffered ceiling also remains intact above a dropped ceiling installed sometime during the mid-20th-Century.

Bertram and Carnegie concluded their pamphlet with the guidelines for the design of the exterior of the library:

It will be noted that no elevations ar [sic] given or suggestions made about the exteriors. These ar [sic] features in which the community and architect may express their individuality, keeping to a plain, dignified structure and not aiming as such exterior effects as may make impossible an effective and economical layout of the interior.<sup>40</sup>

The exterior of the Bradley Beach Free Public Library is indeed a simple, "dignified structure," emblematic of the exterior design of small Carnegie Libraries constructed during the early 20th-Century: it is a restrained classical style with monumental stone steps leading to a central entrance.<sup>41</sup>

The Bradley Beach Free Public Library was designed by Emil Henry Schmieder who served as the municipal engineer and architect for both Bradley Beach and Spring Lake during the late 1920s and 1930s. Emil Henry Schmieder, was responsible for several notable and ambitious civic structures in both Bradley Beach and Spring Lake. His work in Bradley Beach included the Esplanade, The Pavillion and Bathing Casino Group and the Newark Avenue Bath houses.<sup>42</sup> Works in Spring Lake included the Frederic A. Duggan Memorial First Aid and Emergency Squad Building, constructed in in 1928, which is listed in the National Register of Historic Places. He also designed the North and South Bathing Pavilions, constructed of brick and steel in 1928 and 1932, respectively. In addition, Emil Henry Schmieder designed the first aid building in Belmar in 1931.

The Bradley Beach Public Library is locally significant as an expression of early 20th-Century small library design, embracing the values of the "Modern Library Idea." The building retains a high degree of integrity, particularly its significant interior features, including original furnishings and finishes, which all remain intact.

---

<sup>40</sup> Ibid., 223.

<sup>41</sup> Mary B. Dierick, *The Architecture of Literacy; Carnegie Libraries in the US*. National Trust for Historic Preservation, November 3, 2006, available from <http://www.carnegielibraries.info/hthp/natltrust-presentation/pdf>.

<sup>42</sup> Office of the Borough of Bradley Beach, Meeting Minutes 1917-1927.

United States Department of the Interior  
National Park Service  
**National Register of Historic Places**  
**Continuation Sheet**

**Bradley Beach Free Public Library**  
**Monmouth County, NJ**

Section number 9 Page 1

---

**Bibliography**

A. Primary Sources:

Library Archives, Bradley Beach Free Public Library, New Jersey.  
Office of the Borough of Bradley Beach, Meeting Minutes 1917-1927.  
Office of the Borough of Bradley Beach, Municipal Ordinance, September 11, 1917.  
Office of the County Clerk, County of Monmouth, Deed for Bradley Beach Library, October 28, 1918.  
Office of the County Clerk, County of Monmouth, Deed for Bradley Beach Library, December 7, 1925.  
James Bertram, *Notes on the Erection of Library Buildings* (sic), version 3, C. 1915.

B. New Jersey Laws

Public Law P.L. 1905, p. 273. "An Act concerning free public libraries."

C. Secondary Sources:

Ayres, Shirley and Troy Bianchi. *Postcard History Series Bradley Beach*. (Portsmouth, NH: Arcadia Publishing, 2004).

Roger McDonough. *A History of New Jersey Libraries 1750-1996*. (The Scarecrow Press, Inc., Lanham, Md., & London 1997).

Theodore Jones. *Carnegie Libraries Across America A Public Legacy*. (New York: John Wiley and Sons, 1997.)

New Jersey State Federation of Women's Clubs. *A Century of Challenge: New Jersey State Federation of Women's Clubs First 100 Years*. (New Brunswick, NJ: NJSFWC, 1994.)

Schultz, Ellen Freedman and Deborah Marquis Kelly. *New Jersey Women's Historic Sites Survey Final Report*. (Trenton: The Alice Paul Centennial Foundation and New Jersey State Historic Preservation Office, Division of the Department of Environmental Protection, Contract Number-HE00-007, February 7, 2003.)

Van Slyck, Abigail A. *Free To All Carnegie Libraries & American Culture 1890-1920*. (Chicago, IL: University of Chicago Press, 1995).

Frank Scott York, "The Honorable James A. Bradley," *75<sup>th</sup> Diamond Jubilee 1893-1968: Commemorative History of the Borough of Bradley Beach, NJ*. (Bradley Beach: Borough of Bradley Beach, 1968.)

Ellen Freedman Shultz and Deborah Marquis Kelly, *National Register Nomination of Clubhouses of NJ Women's Clubs MPDF*, Section E.

Paula D. Watson, "Founding Mothers: The Contribution of Women's Organizations to Public Library Development in the United States", (*Library Quarterly*, Vol. 64, Issue 3, 1994.)

Borough Council, "Souvenir Booklet: Bradley Beach, NJ" (Bradley Beach: JT Kinney, The Sea Coast News, 1913). The Borough published several Souvenir Booklets during the early 20<sup>th</sup>-century, which described Bradley Beach and promoted the quality of life in this resort community. There are no page numbers.

United States Department of the Interior  
National Park Service  
**National Register of Historic Places**  
**Continuation Sheet**

**Bradley Beach Free Public Library**  
**Monmouth County, NJ**

Section number 9 Page 2

---

Abigail A. Van Slyck, "*Free to All: Carnegie Libraries and American Culture 1890-1920*," (Chicago: The University of Chicago Press, 1995.)

*The Woman's Improvement League (Handbook).*

Ellen Freedman Schultz and Deborah Marquis Kelly, *New Jersey Women's Historic Sites Survey Final Report*, (Trenton: New Jersey State Historic Preservation Office and the Alice Paul Centennial Foundation, February 7, 2003).

D. Articles

Paula D. Watson, "Founding Mothers: The Contribution of Women's Organizations to Public Library Development in the United States", *Library Quarterly*, Vol. 64, Issue 3, 1994.

"Jas A. Bradley dies; founder of Asbury," *The New York Times*, June 7, 1921.

"Bradley Beach", *Asbury Park Evening Press*, April 18, 1914.

*The Woman's Improvement League Annual Report*, Bradley Beach: NJ, 1913.

"Bradley Beach Lively", *The New York Times*, May 31, 1914.

"Tag Day Nets Library \$315", *Asbury Park Evening Press*, August 3, 1914.

"Bradley Beach Library Dedicated", *Asbury Park Evening Press*, December 2, 1927.

E. On-Line Article

Mary B. Dierick, *The Architecture of Literacy; Carnegie Libraries in the US*. National Trust for Historic Preservation, November 3, 2006, available from <http://www.carnegielibraries.info/hthp/natltrust-presentation/pdf>.

F. Website

Barbaranne M. Warner, "Sarah Byrd Askew," October, 2003, <http://www.webspanner.com/users/sarahaskew>.

United States Department of the Interior  
National Park Service

# National Register of Historic Places Continuation Sheet

Bradley Beach Free Public Library  
Monmouth County, NJ

Section number 10 Page 1

---

## 10. Geographical Data

### Verbal Boundary Description

The boundary comprises block 61, lot 1, as shown on the Bradley Beach tax map. The boundary is shown as a dark/bold line on the accompanying map entitled "Site Plan." As stated in the deed, dated October 28, 1918: The boundary begins at the southeast corner of Fourth Avenue and Hammond Avenue; from this point the boundary extends eastward, along the south line of Fourth Ave. one hundred (100) feet; from this point the boundary extends southward at right angles to Fourth Avenue one hundred and fifty (150) feet; from this point the boundary extends westward (parallel to Fourth Avenue) one hundred (100) feet to the east line of Hammond Avenue; from this point the boundary extends northward along the east line of Hammond Ave., one hundred and fifty (150) feet to the south line of Fourth Avenue.

### Boundary Justification

The boundaries of the Bradley Beach Free Public Library Property are identical to the original property boundaries.

United States Department of the Interior  
National Park Service  
**National Register of Historic Places**  
**Continuation Sheet**

**Bradley Beach Free Public Library**  
**Monmouth County, NJ**

Section Additional Page 1  
number Documentation:  
Photographs \_\_\_\_\_

City or Vicinity: Bradley Beach  
Photographer: As indicated on table below.

County: Monmouth  
Dates Photographed: As indicated on table below.

| Number   | Description  | Photographer                | Date    |
|----------|--|-----------------------------|---------|
| 1 of 34  | Exterior: North Elevation, view looking southeast.   | Michael Calafati            | 2/2011  |
| 2 of 34  | Streetscape: View looking east on Fourth Avenue toward beachfront.   | Lisa Soderberg              | 1/2013  |
| 3 of 34  | Exterior: North elevation, view looking north.   | Lisa Soderberg              | 11/2012 |
| 4 of 34  | Exterior: West (side) elevation facing Hammond Avenue, view looking east.  | Lisa Soderberg              | 11/2012 |
| 5 of 34  | Exterior: South (rear) elevation, view looking north.  | Lisa Soderberg              | 1/2013  |
| 6 of 34  | Exterior: East (side) elevation, view looking northwest.   | Lisa Soderberg              | 1/2013  |
| 7 of 34  | Exterior: East (side) elevation and front façade, view looking southwest.  | Lisa Soderberg              | 1/2013  |
| 8 of 34  | Exterior: Detail view of portico pediment above front entry, view looking south.                                 | Sophia Jones                | 8/2012  |
| 9 of 34  | Exterior: Detail view of brick quoins at the south corner of the west (side) elevation, view looking east.       | Lisa Soderberg              | 1/2013  |
| 10 of 34 | Exterior: Detail view of limestone columns at portico, view looking southeast.                                   | Lisa Soderberg              | 11/2012 |
| 11 of 34 | Exterior: Detail view of tile and standing seam metal roofs, view looking east.                                  | Annabelle Radcliffe-Trenner | 11/2012 |
| 12 of 34 | Exterior: Detail view of one of the pair of octagonal windows that flank the front entrance, view looking south. | Lisa Soderberg              | 11/2012 |
| 13 of 34 | Exterior: Detail view of the metal clad wood doors at the front entrance, view looking south.                    | Sophia Jones                | 8/2012  |
| 14 of 34 | Exterior: Detail view of basement entrance at the south (rear) elevation, view looking northwest.                | Lisa Soderberg              | 1/2013  |
| 15 of 34 | Interior: Detail view of door between the vestibule and the Main Reading Room, view looking south.               | Lisa Soderberg              | 1/2013  |
| 16 of 34 | Interior: Detail view of original circulation desk, view looking south.  | Sophia Jones                | 8/2012  |
| 17 of 34 | Interior: Detail view of entry vestibule, view looking northwest.  | Annabelle Radcliffe-Trenner | 1/2013  |
| 18 of 34 | Interior: Detail view of memorial plaque in vestibule, view looking east.  | Annabelle Radcliffe-Trenner | 1/2013  |
| 19 of 34 | Interior: Main Reading Room on first floor, view looking southeast.  | Lisa Soderberg              | 1/2013  |
| 20 of 34 | Interior: Detail view of circulation desk, view looking south.   | Sophia Jones                | 8/2012  |
| 21 of 34 | Interior: Detail view of dumbwaiter access door in Main Reading Room, view looking northwest.                    | Lisa Soderberg              | 1/2013  |
| 22 of 34 | Interior: Detail view of staff bathroom on the first floor, view looking north.                                  | Lisa Soderberg              | 1/2013  |

United States Department of the Interior  
National Park Service  
**National Register of Historic Places**  
**Continuation Sheet**

**Bradley Beach Free Public Library**  
**Monmouth County, NJ**

Section Additional Page 2  
number Documentation:  
Photographs \_\_\_\_\_

|          |  |                  |        |
|----------|--|------------------|--------|
| 23 of 34 | Interior: Detail of original bookcases in Main Reading Room, view looking northwest.   | Lisa Soderberg   | 1/2013 |
| 24 of 34 | Interior: Detail view of stairs from Main Reading Room to the basement, view looking north.                                  | Lisa Soderberg   | 1/2013 |
| 25 of 34 | Interior: Detail view of original bookcases in Main Reading room, view looking east.   | Lisa Soderberg   | 1/2013 |
| 26 of 34 | Interior: Detail view of perimeter bookcases between and below the windows in the Main Reading Room, view looking south.     | Lisa Soderberg   | 1/2013 |
| 27 of 34 | Interior: Detail view of original cork floor pattern in the southwest corner of the Main Reading Room, view looking north.   | Sophia Jones     | 8/2012 |
| 28 of 34 | Interior: Detail view of original marble baseboard in Main Reading Room adjacent to the entry vestibule, view looking south. | Lisa Soderberg   | 1/2013 |
| 29 of 34 | Interior: Detail view of original ornamental plaster ceiling in Main Reading Room, view looking south.                       | Michael Calafati | 2/2011 |
| 30 of 34 | Interior: Hall and circulation space in basement, view looking north.  | Lisa Soderberg   | 1/2013 |
| 31 of 34 | Interior: Children's Reading Room in basement, view looking west.  | Lisa Soderberg   | 1/2013 |
| 32 of 34 | Interior: Reference and office area in basement, view looking northwest.   | Lisa Soderberg   | 1/2013 |
| 33 of 34 | Interior: Barrier-free bathroom in basement, view looking northeast.   | Lisa Soderberg   | 1/2013 |
| 34 of 34 | Interior: Detail view of original coal conveyance mechanism in boiler room, view looking south.                              | Lisa Soderberg   | 1/2013 |

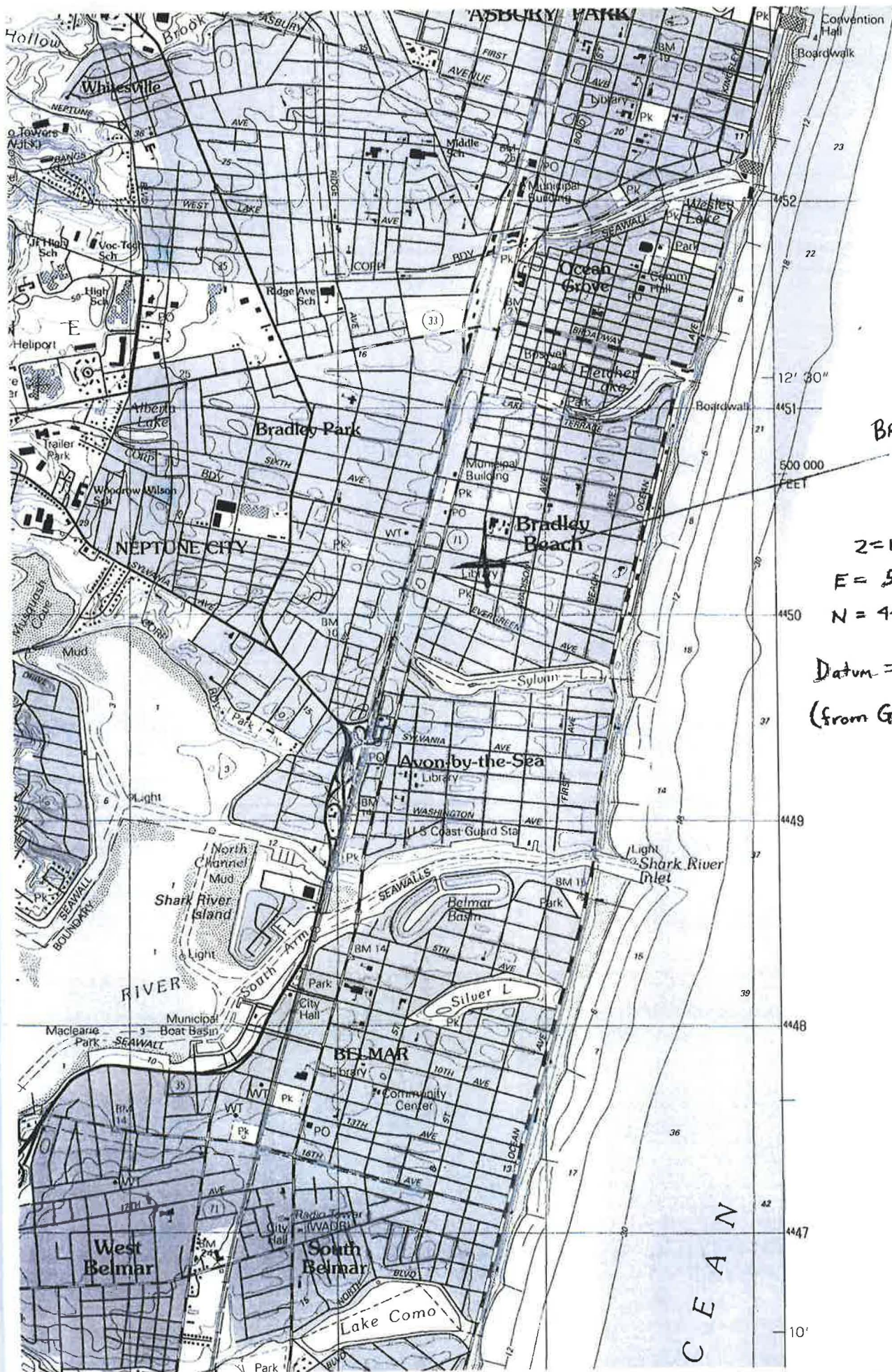

BRADLEY BEACH  
FREE PUBLIC  
LIBRARY

Z=18  
E= 583730  
N= 4450965

Datum = NAD 27  
(from GoogleEarth)



National Historic Register Nomination

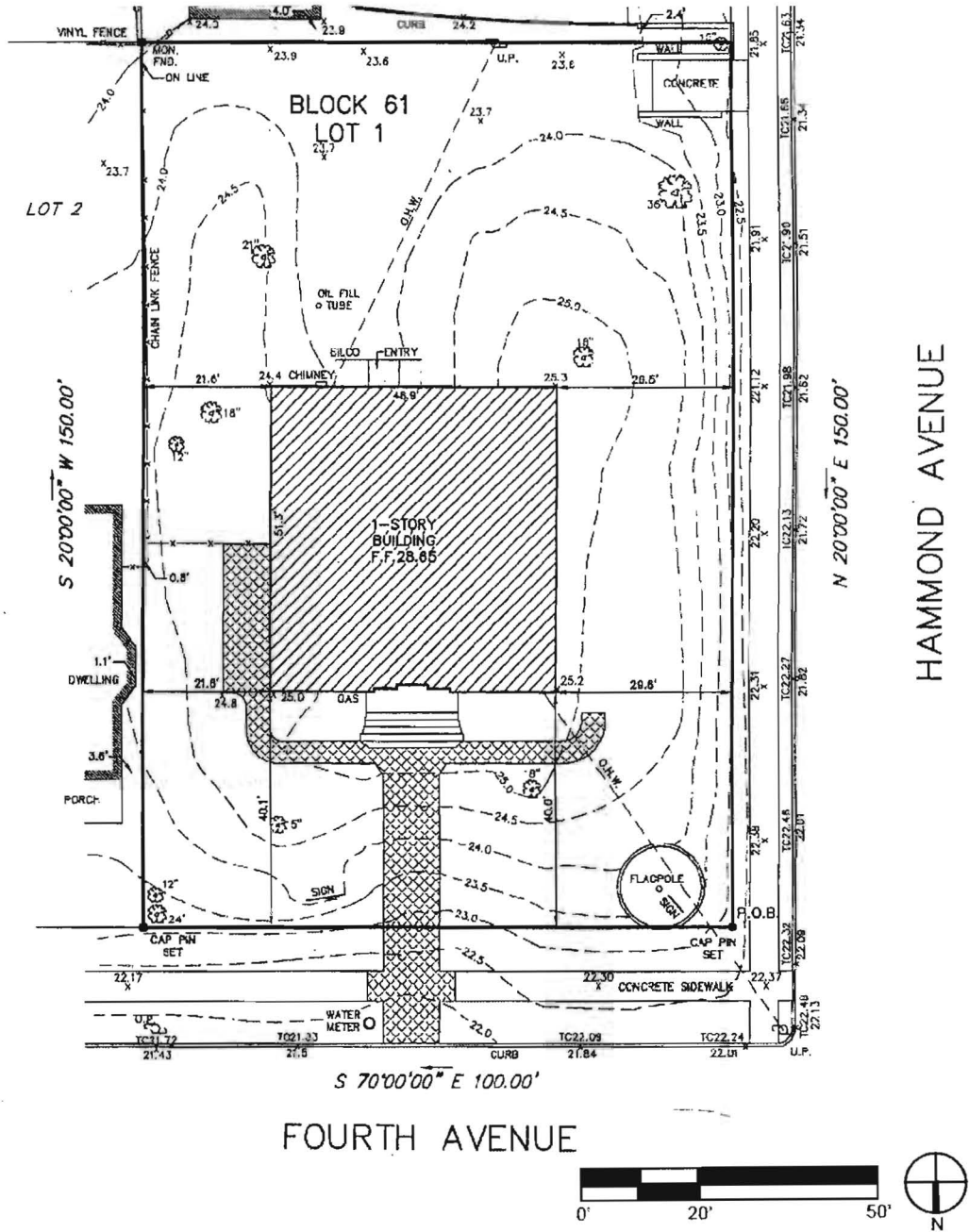

SITE PLAN

Bradley Beach Free Public Library  
Bradley Beach, Monmouth County, NJ

National Historic Register Nomination

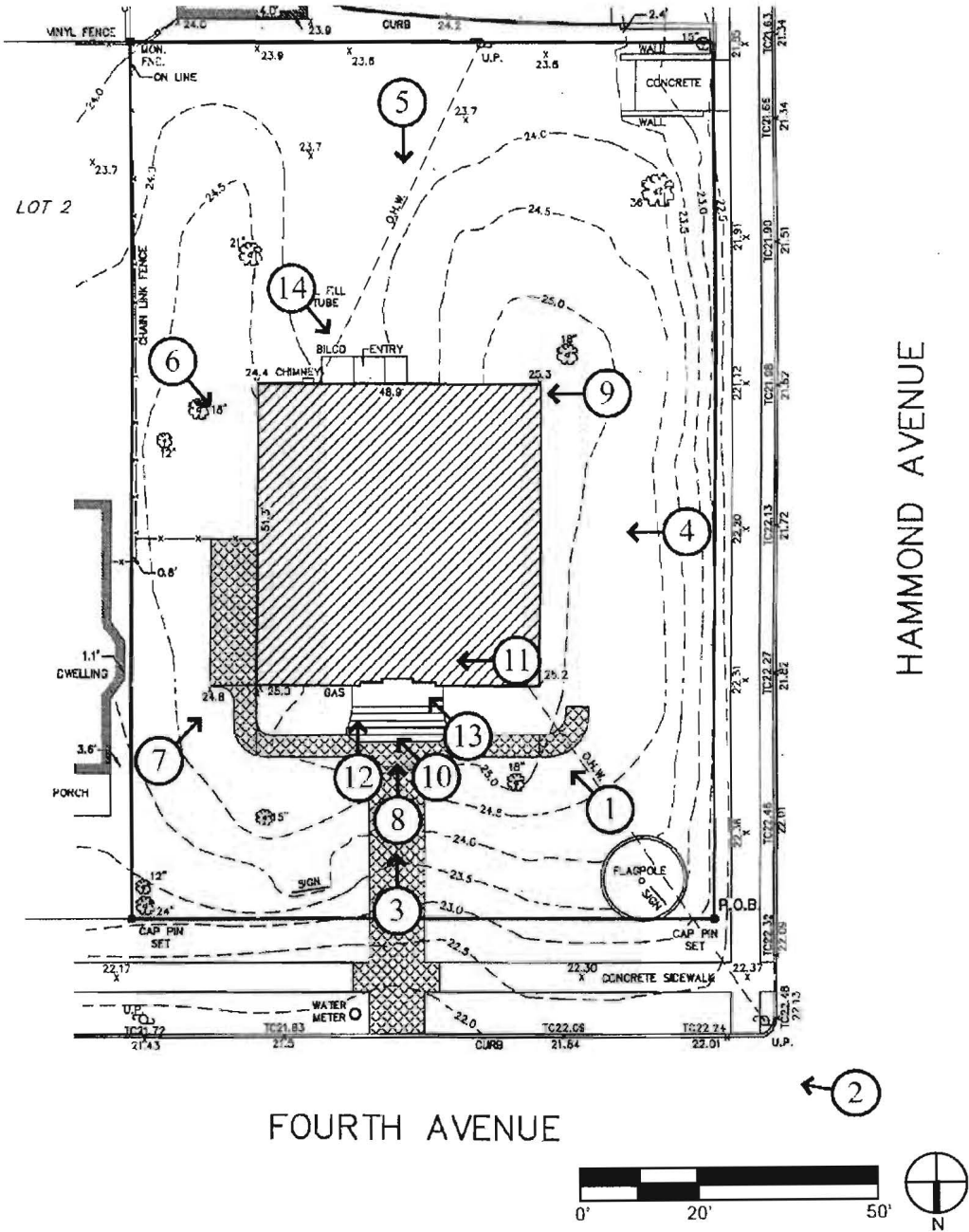

**SITE PLAN**  
(ANNOTATED FOR PHOTOGRAPHS)

Bradley Beach Free Public Library  
Bradley Beach, Monmouth County, NJ

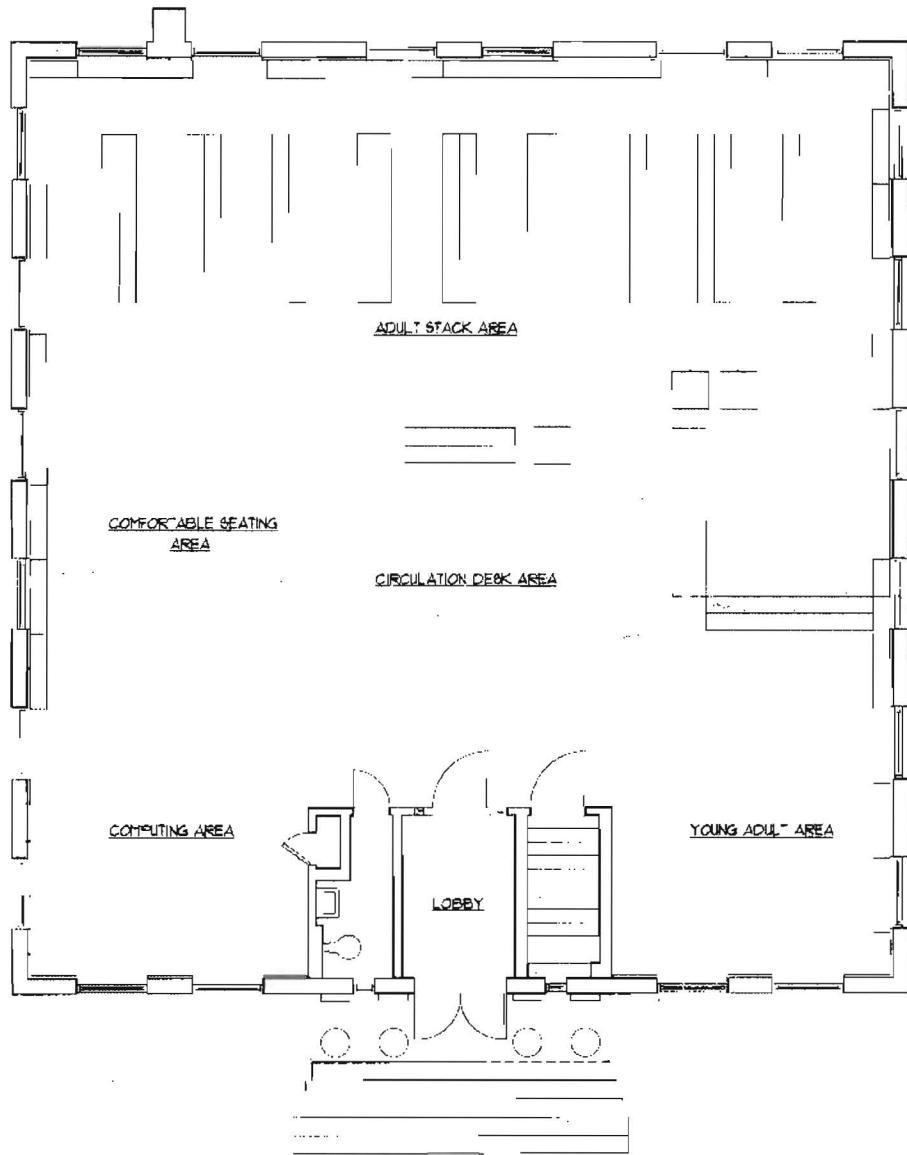

**FIRST FLOOR PLAN**

Bradley Beach Free Public Library  
Bradley Beach, Monmouth County, NJ

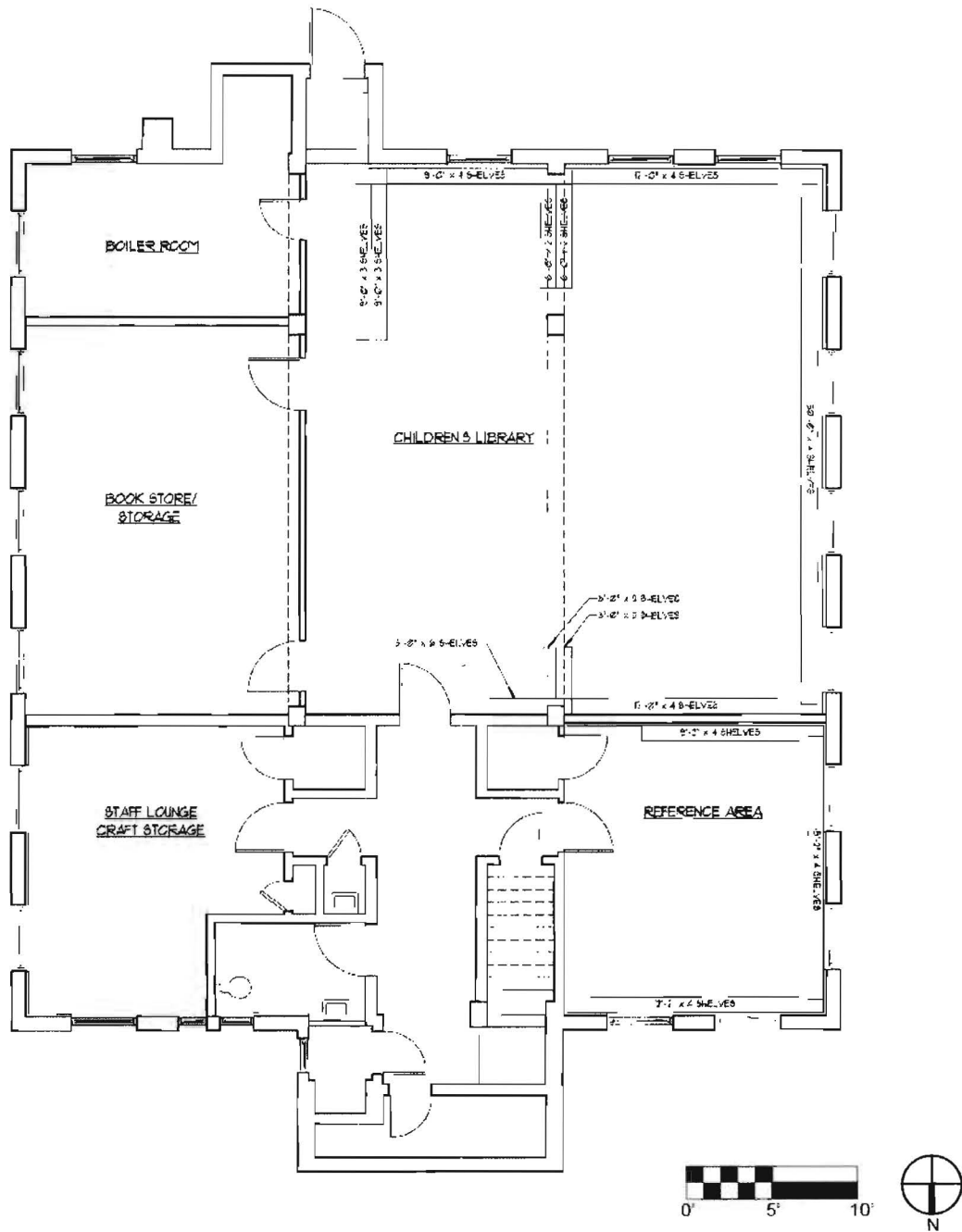

**BASEMENT FLOOR PLAN**

Bradley Beach Free Public Library  
Bradley Beach, Monmouth County, NJ

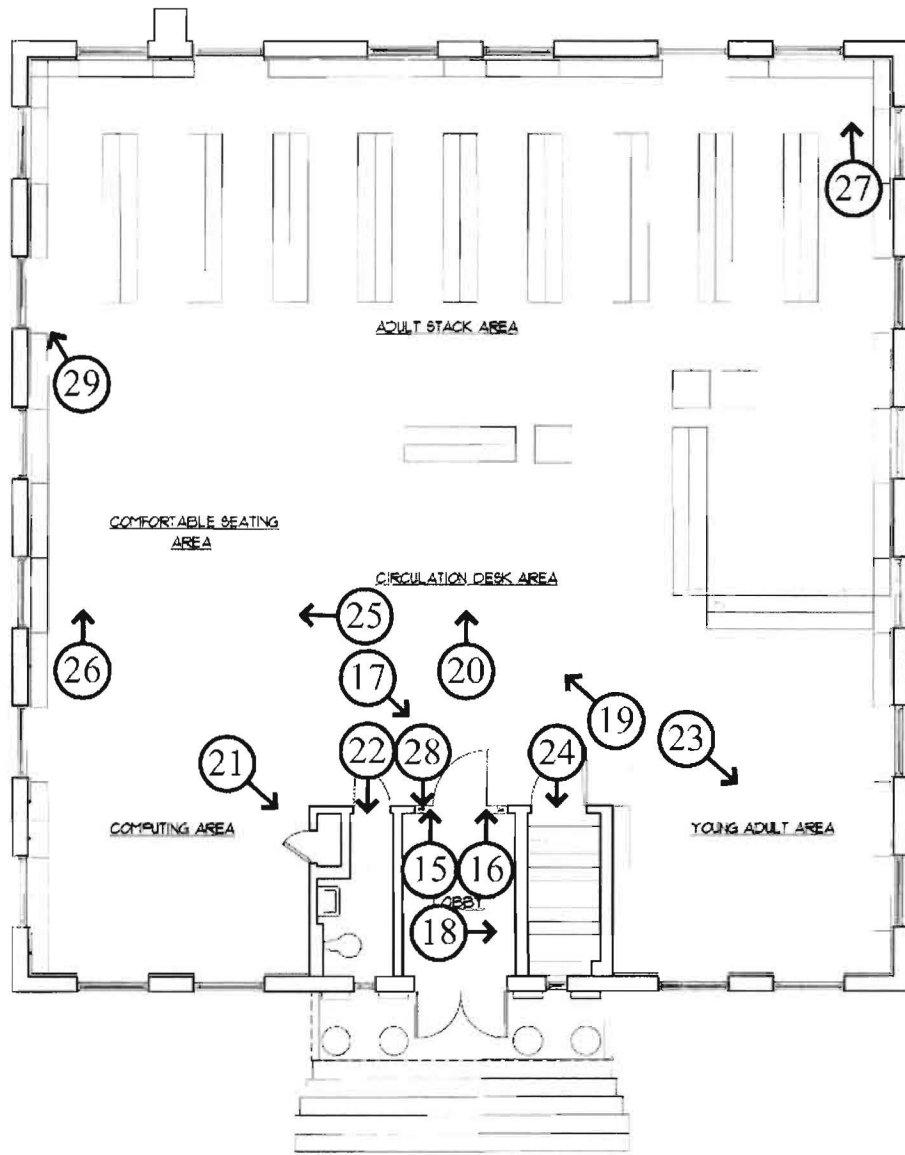

Photograph 8 of 30:



**FIRST FLOOR PLAN**  
(ANNOTATED FOR PHOTOGRAPHS)

Bradley Beach Free Public Library  
Bradley Beach, Monmouth County, NJ

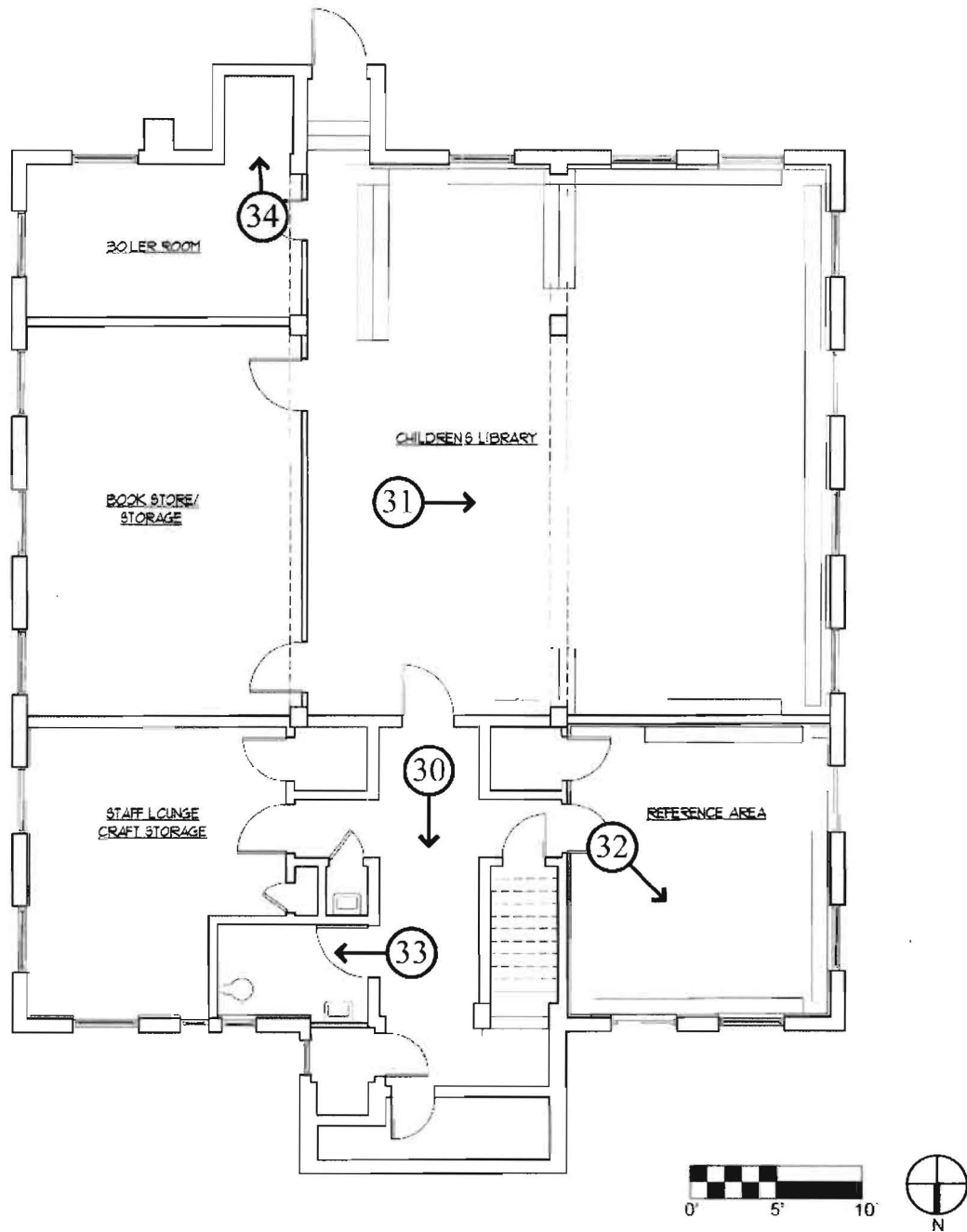

**BASEMENT FLOOR PLAN**  
(ANNOTATED FOR PHOTOGRAPHS)

Bradley Beach Free Public Library  
Bradley Beach, Monmouth County, NJ

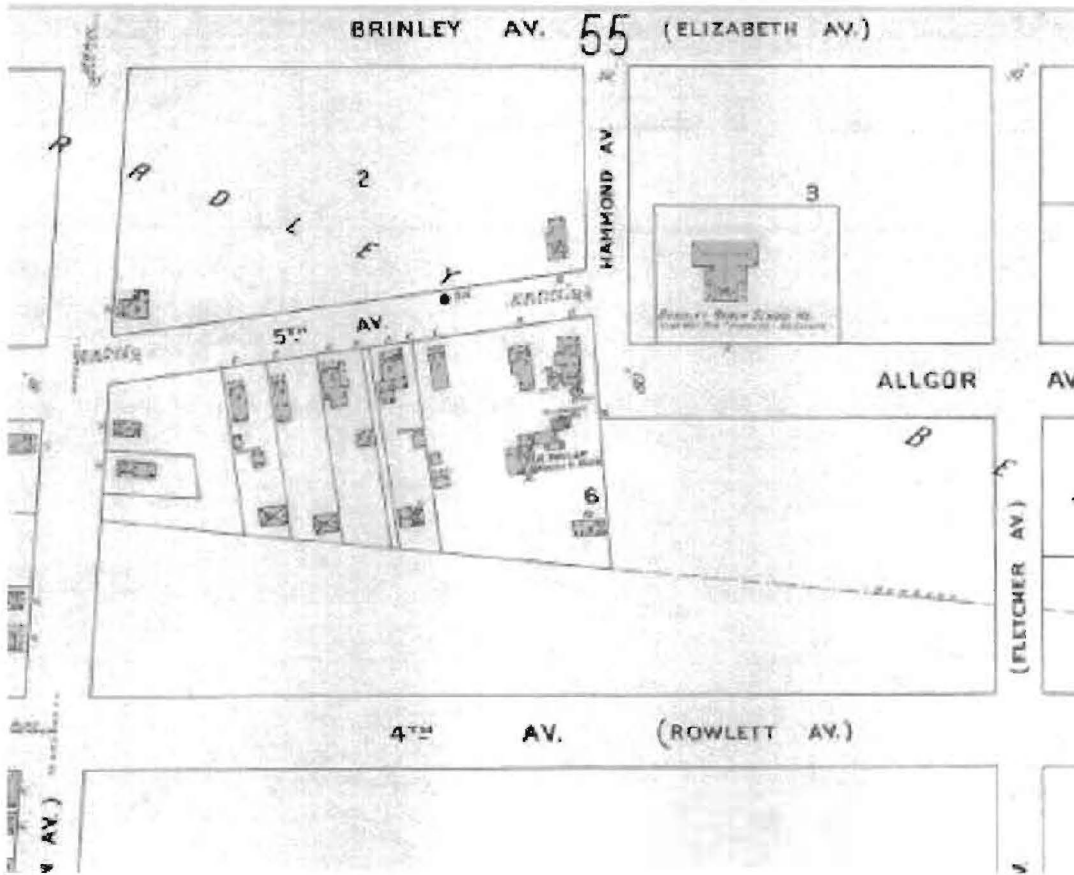

**Figure 1 of 6:**

1905 Sanborn map showing location of library site before Hammond Avenue was extended to Fourth Avenue. Note the Bradley Beach Public School (grammar) at the intersection of Fifth Avenue and Hammond Avenue. During its first year, the library was located in a room in the Grammar School.

Bradley Beach Free Public Library  
Bradley Beach, Monmouth County, NJ

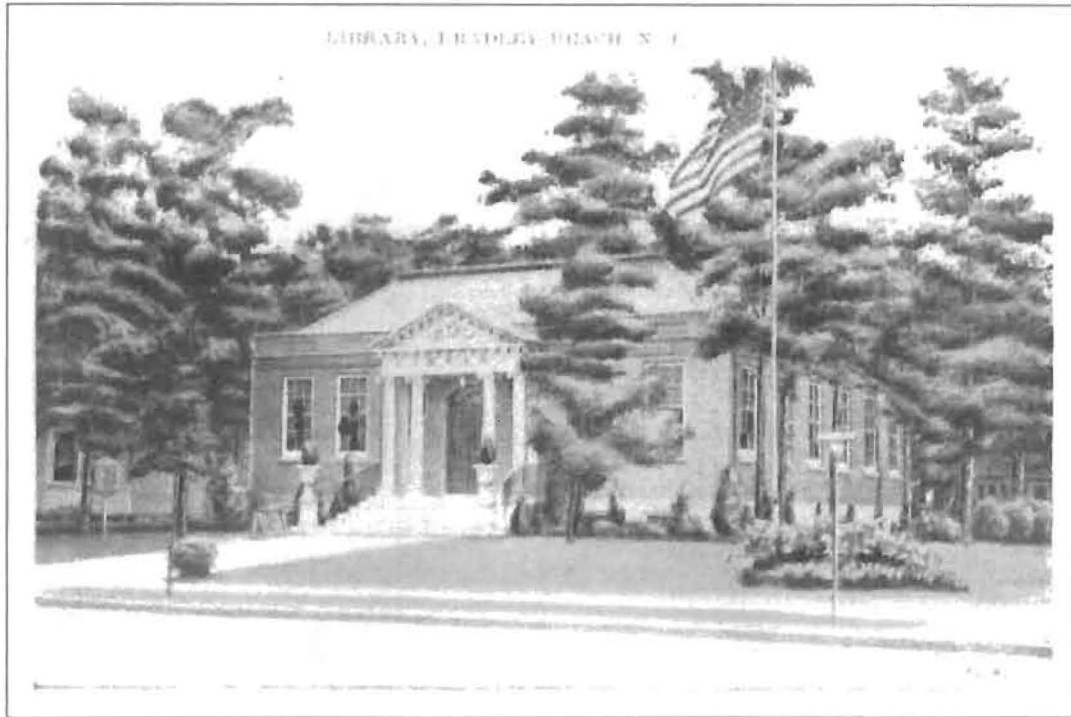

**Figure 2 of 6:**

Historic view of the Bradley Beach Public Library at the corner of Hammond Avenue and 4th Avenue ca. 1950s, view looking southeast.

Bradley Beach Free Public Library  
Bradley Beach, Monmouth County, NJ





**Figure 3 of 6:**

Historic postcard of the Bradley Beach Free Public Library in the 1920s and 1930s, view looking southeast.

Bradley Beach Free Public Library  
Bradley Beach, Monmouth County, NJ



**Figure 4 of 6:**

Historic interior image of the Bradley Beach Free Public Library looking southeast, showing the original circulation desk, coffered ceiling and light fixtures, ca. 1930s-1940s.

Bradley Beach Free Public Library  
Bradley Beach, Monmouth County, NJ



**Figure 5 of 6:**

Historic photograph of the main circulation desk at Bradley Beach Free Public Library, ca. 1950s.

Bradley Beach Free Public Library  
Bradley Beach, Monmouth County, NJ

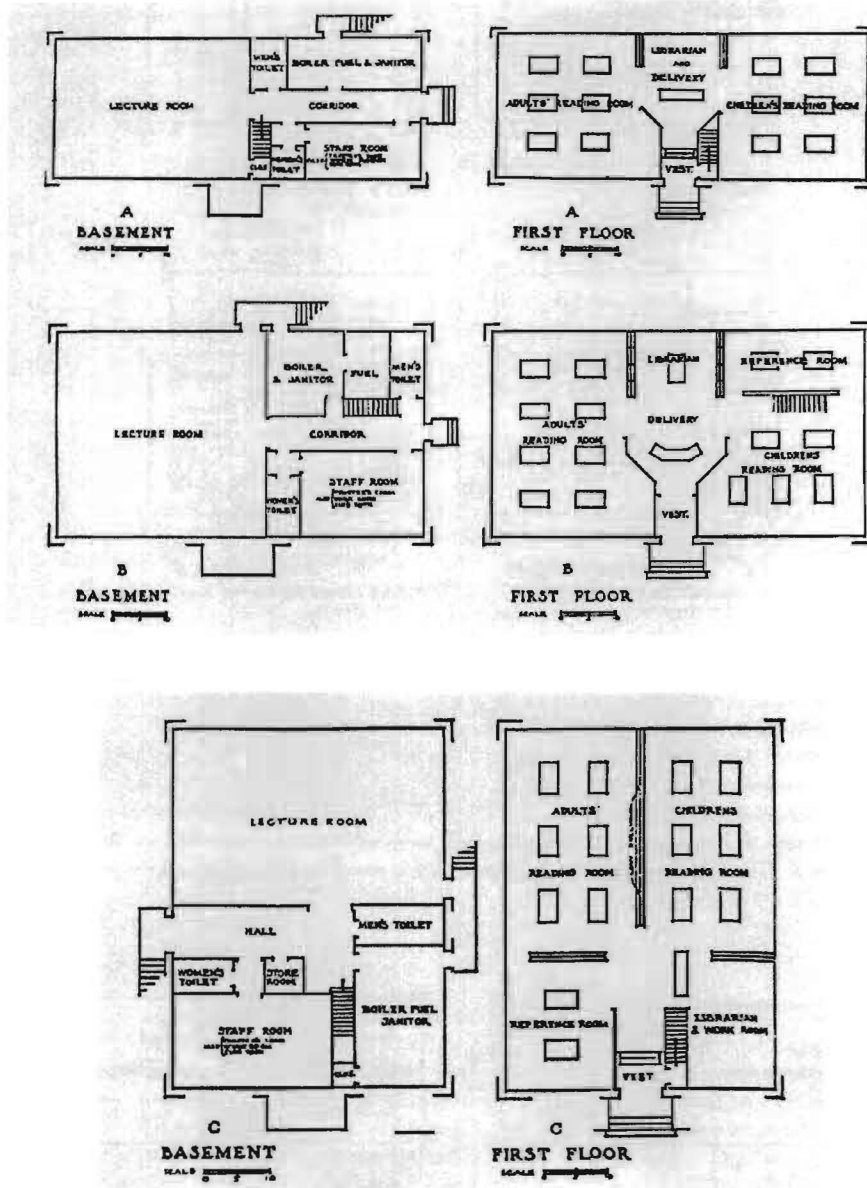

Figure 6. of 6:

Excerpt from “Notes on the Erection of Library Buildings” [sic] showing prototypical interior arrangements for small libraries recommended by Andrew Carnegie and his secretary, James Bertram. The designs feature central circulation desks, stacks along the perimeter walls, and narrow stairs adjacent to the main entry to maximize usable space.

Bradley Beach Free Public Library  
Bradley Beach, Monmouth County, NJ



1-800-**PACK-RAT**  
STORAGE & MOVING  
1-800-  
[www.1800packrat.com](http://www.1800packrat.com)



FOURTH AVE  
HAMMOND AVE

Y64CAT



LIBRARY













LIBRARY

Dream Big  
READ!











WELCOME TO THE  
BRADLEY BEACH PUBLIC  
LIBRARY!  
WE ARE HAPPY  
TO HELP YOU

**NO  
SMOKING**

LIBRARY HOURS  
Monday, Wednesday, & Friday  
9:00am - 5:00 pm  
Tuesday, Thursday  
9:00am - 4:00 pm  
Saturday, 9am - 2 pm  
Sunday, CLOSED







WELCOME TO THE  
BRADLEY BEACH PUBLIC  
LIBRARY!  
WE ARE HAPPY  
TO HELP YOU

WORLDWIDE  
GREEN'S  
WEAVE



A large, dark, rectangular plaque mounted on a wall of white and grey marbled stone. The plaque contains a list of names, likely members of a group or organization, arranged in three columns. The text is small and difficult to read in detail, but appears to be a roster of individuals.

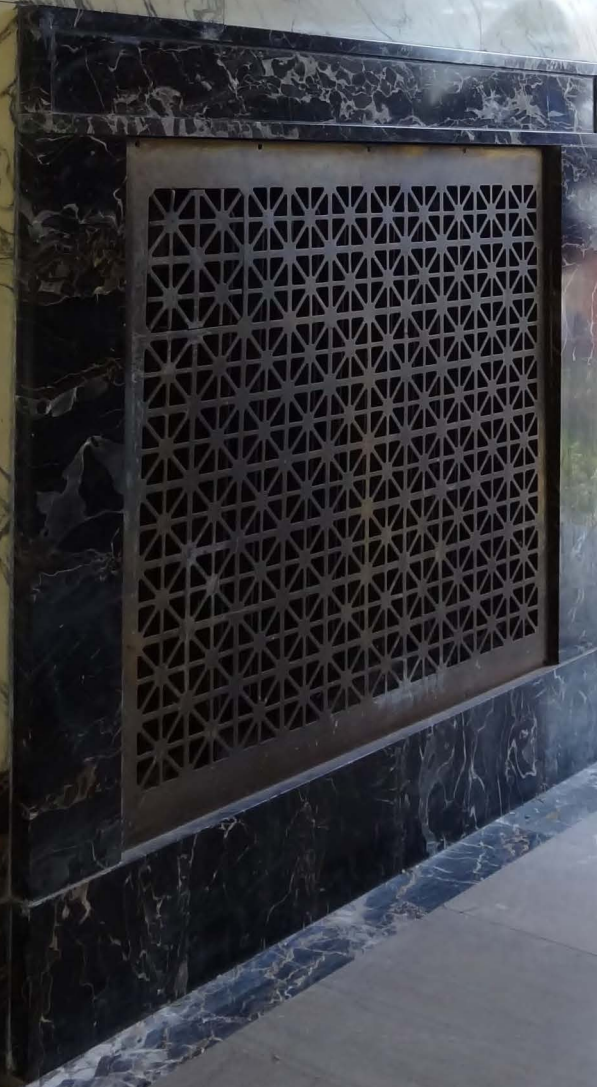

THE  
BRADLEY BEACH  
FREE PUBLIC LIBRARY  
ERECTED 1927

FOUNDED BY THE WOMEN OF BRADLEY BEACH  
LAND GIVEN BY HON. JAMES A. BRADLEY  
BUILDING ERECTED BY THE BOROUGH

CLARENCE W. SMITH — PRESIDENT  
JOSEPHINE STILES — VICE PRESIDENT  
MINNIE F. VAN KIRK — SECRETARY  
FRIEDA LEPINE — TREASURER  
HATTIE ROGERS — HOUSE CHAIRMAN  
MABELLE S. CLARK — LIBRARIAN  
FRANK C. BORDEN JR. — MAYOR  
BERNARD V. POLAND — COMMISSIONER  
JOHN ROGERS — COMMISSIONER

E. H. SCHMIEDER  
ARCHITECTURAL ENGINEER

H. H. MOORE INC.  
BUILDERS





Informational sign with a pink header and several lines of text, possibly a library policy or notice.

WELCOME TO THE  
BRADLEY BEARD PUBLIC  
LIBRARY  
WE ARE OPEN  
EVERY DAY

DONATION  
BOX  
PLEASE USE  
FOR YOUR  
DONATIONS

THE FLAG  
OF THE  
UNITED STATES  
OF AMERICA

THANK YOU  
FOR  
YOUR  
LIBRARY CARD





Fire Alarm

Temperature Control Panel

Copies are .25 cents per page

Please Pay at the Creditation Desk

Thank You!



ROCKDALE  
COUNCILHOUSE

How Many Farming Cows Trough

Time & Nature & Everyday Life

Who better fitness

DISASTER ASSISTANCE







BOOK SALE!!

JOHN SANDFORD  
ROGUE KNIGHT ON THE RED CELL  
GROTESQUE'S MASCOT APPEARS  
MURDERER'S MASCOT APPEARS  
THE BROTHERS  
THE INVENTION OF SOLITUDE  
THE SECRET GARDEN  
THE BOOK OF DAVID

FRIEND  
YOUR  
LIBRARY

SIGN UP  
for a library card!

BORROW  
books, DVDs, audiobooks, and more

ATTEND  
programs and events at your library.  
Bring a friend!

VOLUNTEER  
your time, energy, and ideas

DONATE  
books or money to your local Friends group

SHARE  
with others what you love about your library

SPEAK  
up and speak out for your library

JOIN  
your library's Friends group

Ask your librarian, or visit [www.ala.org/ala](http://www.ala.org/ala)



WINTER  
SALE







WOMEN

THE BEST OF US

PRICE OF INEQUALITY

THEY DON'T GET IT, DO THEY?

he's just not that into you

gift











EXIT

ELECTRICAL ROOM

Mural was donated  
by  
Friends of the Library  
and  
Mayor Steve Squitieri



RELAX AND ENJOY SOME COLORING







UNITED STATES DEPARTMENT OF THE INTERIOR  
NATIONAL PARK SERVICE

NATIONAL REGISTER OF HISTORIC PLACES  
EVALUATION/RETURN SHEET

REQUESTED ACTION: NOMINATION

PROPERTY NAME: Bradley Beach Free Public Library

MULTIPLE NAME:

STATE & COUNTY: NEW JERSEY, Monmouth

DATE RECEIVED: 11/08/13      DATE OF PENDING LIST: 12/09/13  
DATE OF 16TH DAY: 12/24/13      DATE OF 45TH DAY: 12/25/13  
DATE OF WEEKLY LIST:

REFERENCE NUMBER: 13000976

REASONS FOR REVIEW:

APPEAL: N DATA PROBLEM: N LANDSCAPE: N LESS THAN 50 YEARS: N  
OTHER: N PDIL: N PERIOD: N PROGRAM UNAPPROVED: N  
REQUEST: Y SAMPLE: N SLR DRAFT: N NATIONAL: N

COMMENT WAIVER: N

ACCEPT       RETURN       REJECT      \_\_\_\_\_ DATE

ABSTRACT/SUMMARY COMMENTS:

RECOM./CRITERIA \_\_\_\_\_

REVIEWER \_\_\_\_\_ DISCIPLINE \_\_\_\_\_

TELEPHONE \_\_\_\_\_ DATE \_\_\_\_\_

DOCUMENTATION see attached comments Y/N see attached SLR Y/N

If a nomination is returned to the nominating authority, the nomination is no longer under consideration by the NPS.



HPO Proj. #12-1872-6  
Chrono #: I2013-235

State of New Jersey

DEPARTMENT OF ENVIRONMENTAL PROTECTION  
NATURAL & HISTORIC RESOURCES

Office of the Assistant Commissioner  
MAIL CODE 501-03A  
PO Box 420  
Trenton, New Jersey 08625  
609-292-3541/FAX: 609-984-0836



BOB MARTIN  
Commissioner

CHRIS CHRISTIE  
Governor

KIM GUADAGNO  
Lt. Governor

September 25, 2013

Paul Loether, Chief  
National Register of Historic Places  
National Park Service  
Department of the Interior  
Washington, D.C. 20240

Dear Mr. Loether:

The enclosed disk contains the true and correct copy of the nomination for the Bradley Beach Free Public Library, Bradley Beach Borough, Monmouth County, New Jersey.

This nomination has received unanimous approval from the New Jersey State Review Board for Historic Sites. All procedures were followed in accordance with regulations published in the Federal Register.

Should you want any further information concerning this application, please feel free to contact Daniel D. Saunders, Administrator, New Jersey Historic Preservation Office, Mail code 501-04B, P.O. Box 420, Trenton, New Jersey 08625-0420, or call him at (609) 633-2397.

Sincerely,

Rich Boornazian  
Deputy State Historic  
Preservation Officer





Joeckel, Jeffery <jeff\_joeckel@nps.gov>

---

## Fwd: Bradley Beach Public Library

1 message

---

**Deline, Lisa** <lisa\_deline@nps.gov>  
To: Jeffery Joeckel <jeff\_joeckel@nps.gov>

Thu, Jan 16, 2014 at 4:15 PM

----- Forwarded message -----

From: **Cannelongo, Kathleen** <Kathleen.Cannelongo@dep.state.nj.us>  
Date: Thu, Jan 16, 2014 at 1:22 PM  
Subject: Bradley Beach Public Library  
To: "lisa\_deline@nps.gov" <lisa\_deline@nps.gov>  
Cc: "Craig, Bob" <Bob.Craig@dep.state.nj.us>

Hello Lisa,

Bob asked me to send the requested UTM Datum for the Bradley Beach Public Library, which is: 1927 North American Datum.

Many thanks for your patience and assistance.

Regards,

Kat Cannelongo

Program Associate

NJ SHPO

—  
Lisa Deline  
Historian  
National Register of Historic Places  
[www.nps.gov/history/nr](http://www.nps.gov/history/nr)