

RECEIVED 2280

MAY 29 2015

United States Department of the Interior
National Park Service

National Register of Historic Places Registration Form

Nat. Register of Historic Places
National Park Service

This form is for use in nominating or requesting determinations for individual properties and districts. See instructions in National Register Bulletin, How to Complete the National Register of Historic Places Registration Form. If any item does not apply to the property being nominated, enter "not applicable." For functions, architectural classification, materials, and areas of significance, enter only categories and subcategories from the instructions.

1. Name of Property

Historic Name: Booker T. Washington High School
Other Names/Site Number: N/A
Name of related multiple property listing: N/A

2. Location

Street & Number: 2104 Milam Street
City or town: Shreveport State: LA 71103 County: Caddo
Not for Publication: Vicinity:

3. State/Federal Agency Certification

As the designated authority under the National Historic Preservation Act, as amended, I hereby certify that this nomination request for determination of eligibility meets, meets the documentation standards for registering properties in the National Register of Historic Places and meets the procedural and professional requirements set forth in 36 CFR Part 60. In my opinion, the property meets does not meet the National Register Criteria.

I recommend that this property be considered significant at the following level(s) of significance:
 national state local

Applicable National Register Criteria: A B C D

Pam Breaux *4-22-15*
Signature of certifying official/Title: Pam Breaux, State Historic Preservation Officer Date
Louisiana Department of Culture, Recreation, and Tourism
State or Federal agency/bureau or Tribal Government

In my opinion, the property meets does not meet the National Register criteria.

Signature of commenting official: Date

Title: State or Federal agency/bureau or Tribal Government

Booker T. Washington High School
Name of Property

Caddo Parish, Louisiana
County and State

4. National Park Certification

I hereby certify that the property is:
 entered in the National Register
 determined eligible for the National Register
 determined not eligible for the National Register
 removed from the National Register
other, explain: _____

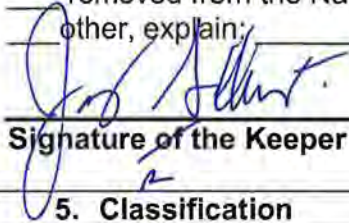
Signature of the Keeper

7.14.2015
Date of Action

5. Classification

Ownership of Property (Check as many boxes as apply.)

	Private
X	Public – Local
	Public – State
	Public – Federal

Category of Property (Check only **one** box.)

X	Building(s)
	District
	Site
	Structure
	object

Number of Resources within Property (Do not include previously listed resources in the count)

Contributing	Non-contributing	
1	4	Buildings
	2	Sites
	1	Structures
		Objects
1	7	Total

Number of contributing resources previously listed in the National Register: 0

6. Function or Use

Historic Functions (Enter categories from instructions.): Education: school

Current Functions (Enter categories from instructions.): Education: school

Booker T. Washington High School
Name of Property

Caddo Parish, Louisiana
County and State

7. Description

Architectural Classification (Enter categories from instructions.): Modern Movement:
International Style

Materials: (enter categories from instructions.)

foundation: concrete

walls: brick, metal

roof: asphalt

other: metal trim

Narrative Description

(Describe the historic and current physical appearance and condition of the property. Describe contributing and noncontributing resources if applicable. Begin with a **summary paragraph** that briefly describes the general characteristics of the property, such as its location, type, style, method of construction, setting, size, and significant features. Indicate whether the property has historic integrity.)

Summary Paragraph

Booker T. Washington High School (also known as BTW HS) is an urban high school sitting on a 33 acre tract located within an African American neighborhood two miles west of the central business district. Constructed next to a busy thoroughfare and within the former southeast corner of a large park, the institution consists of two masonry buildings, both of which are being classified as International Style for the purposes of this nomination. Built in the style of modernist architecture, it is a two story steel framed building using brick curtain exterior walls, glass, and metal to denote its architectural elements. BTW's main structure, which contains 55 classrooms is landscaped into the contours of a relief which comprises a local park called Lakeside Park. Despite the later addition of ancillary buildings and structures to the campus, the original buildings retain their integrity and National Register eligibility.

Narrative Description

Booker T. Washington High School was constructed in the late 1940s and formally opened on January 23, 1950. The Mid-Century Modern style of architecture sits comfortably and naturally into the gentle sloping contours of its physical setting without disrupting the then or current neighborhood's urban environment. The setting of this building is impressive with its "finger" arrangement of parallel wings tied seamless with green open space between the wings as well as elegantly using the sloping ground to mask its impressive bulk and presence. When viewed from different angles of the property, the building in its entirety appears to be different, but with design elements tying these views into a continuous building. The building is at once simple, but yet complex sitting within its 33 acre campus.

Original School Building (contributing) (Photos 1-37)

The school's skeleton of steel joists, decks and tussles rests upon a foundation of concrete with the building finger-shaped design covered with brick curtain walls. From an aerial view, it appears there are six buildings defined by the wings extending from a central core; however, all of the wings are interconnected to form one contributing school building (See the sketch map for the labels – Units A-F – for each wing). The long rows of metal sash windows providing direct sunlight into the interior of the building are accented by metal panels that runs along their tops. This metal trim appears to be a

Booker T. Washington High School

Name of Property

Caddo Parish, Louisiana

County and State

band furthering tying the wings into a single massive building large enough to accommodate a student body of 1,500 students within 55 classrooms and the common assembly areas of administrative offices, auditorium with stage, band room, gymnasium, green house, and manual training wing as well. It is noteworthy that three of the six parts of the building are two storied with the remainder three being one storied. The setting is superb and due to the artful use of the contours of the property and straight lines of the wings, the school seems much larger in its mass and height. The school's gym was originally built at the very center of the wings as if symbolizing the use of physical strength as a unifying element. Besides a few non-contributing additions to the site, including a larger gymnasium, the physical footprint of Booker T. Washington High School retains its historic integrity that was original to the intent and vision of the architects who designed this historic building.

The school was originally constructed with six parts with each part noted as "Unit" with identifying labels of A through F. In order to easily describe the architectural details of the school building, the six Units will be described individually.

Unit A; Auditorium and Band Room (Photos 29, 34-37, 48-52)

Exterior – The siting of Unit A masterfully blends the building into the bottom of a slope. The sloping contour of the ground serves to conceal the massive size of the Unit containing the auditorium and band room. When standing at the main entrance (Unit B) and looking south, a visitor can see the auditorium and band room wall facing Milam Street. Descending the steps, one realizes transitioning towards an auditorium that is two storied. The one-storied band room at the very southern end of Unit A blends into the architectural style with ease and naturally blends in with the larger auditorium.

The exterior of Unit A is clad in the same red brick, ribbon s of metal windows, and metal panel trim found elsewhere on the main school building. The auditorium has a ribbon of windows, which are covered with curtains on the interior and the stage area and back of house is seen as the blank brick wall on the exterior. The band room has a smaller ribbon of windows, single lite, capped by the metal trim. There is a small addition to the band room's eastern elevation, which used the same materials and details so that it blends in with the original design. The original ribbon windows can be seen located just to the north of Unit A's most eastern exit door.

Interior – The auditorium appears at once to be vintage but quite functional. Its gently sloping aisles (one central and two outer aisles) and rows of seating appears to reflect the unseen slope of the natural hillside outside its western exterior wall. The aisles and rows naturally flow towards an ample stage that is open and inviting. Walking along the outer aisles towards the stage, the aisles begin to gently bend towards the stage as the walls in this part of the auditorium are angled toward the stage. Indeed the stage is the focal point for the entire large, open space auditorium. As the stage is large, the separate band room in the adjacent building has intimate practice rooms for individual or small group musical practice as well as a larger space for the entire ensemble to practice. The only interior alteration is in the same area mentioned above; a small addition to the band room. There have been minor cosmetic updates such as carpet, but otherwise, the interior of Unit A, including original auditorium features, is intact.

Unit B; Gym, Entrance, Cafeteria and Hallways (Photos 1, 21, 24-26, 45-46)

Exterior – The most interesting feature of BTW HS is Unit B in that upon approaching the main doors, a visitor looks at a two storied building with its artful use of brick, glass (windows) and metal trim. But if approaching from the rear side of Unit B; a visitor is looking at a two storied building graciously and comfortably sitting upon a gentle contour slope. But then the three elements of brick, glass (windows)

Booker T. Washington High School

Name of Property

Caddo Parish, Louisiana

County and State

and metal trim ties into one regardless of the elevation and slope of the ground. The original windows on the eastern side of Unit B's main entrance have been replaced by glass blocks. However, the brick and metal trim maintains the historic integrity of the original intent of the architects. An addition was made to the main entrance to capture space for administrative offices so that the eastern side of the façade of Unit B was extended a bit. Looking at photo 34, if one looks at the area of glass block windows on the façade of Unit B, one will notice the original metal paneling on the eastern elevation of Unit B. This is where the original façade stopped; thus, about 15 feet of office space was built extending south from the original façade. Original details such as ribbon windows were picked up on and the glass block was installed in a long ribbon. While this is an alteration, it does not significantly impact the school's overall integrity. When comparing any of the historic photos to current photos, one can see that the glass block is new, but it is still clear that this is the same school as seen in the historic photos.

Interior – The siting of Unit B is the very heart of the structure forming the central artery where the other Units tie into the whole. Containing the main entrance to the school, this Unit contains the largest open areas including the gymnasium and cafeteria as well as the administrative offices of the Principal and operational staff. The gymnasium with its exposed steel beams and industrial style windows near the ceiling connecting the walls with the ceiling is still in use. The only alteration is that the windows have been replaced, but within their original opening size, maintaining the “factory” look that the school had and still has today (see Section 8's mention of a *Life* magazine article and Figure 16). The basketball court runs the full length of this open space with one set of accordion style wooden bleachers to the side. The cafeteria is still in use and its open area is flexible enough to conduct other activities as well. The walls are beige tile and the floors are linoleum. Its windows overlook the majority of the property facing the baseball diamond and football stadium. The beige tile walls in the cafeteria match the beige tile walls (2/3 height) found throughout the school's hallways. The hallways also feature single doors with transoms above (which are painted) and rows of lockers line the length of the main hallways. The floors throughout the hallways are terrazzo.

Unit C: Classrooms (Photos 2-6, 40)

Exterior – This two story, prominent wing is clad in the same red brick found elsewhere layered on top by a continuous line of windows capped the entire length by metal trim. The visual of the exterior of Unit C from Milam Street becomes the benchmark of connectivity for the rest of this building from whatever side is approached. This is the face of the school as seen from Milam Street and details found on this Unit are repeated on the rest of the school building. Above each window, the top sash is painted maroon, one of the school's colors, that further helps to create this distinct horizontality for the exterior. The western elevation of Unit C features a projects brick covered entrance capped by three single lite metal windows in a row and metal paneling. The northern elevation of Unit C mirrors the southern elevation.

Interior – this long Unit has a main hallway with classrooms on both sides. It appears this hallway is as long as the primary hallway that runs the length of Unit B from the main entrance to the rear entrance. And to transition from Unit B to Unit C, there is a very slight but definite upward slope. Unit C also showcases one of the innovative features of BTW HS when constructed in 1949 - the main hallway containing the metal lockers for individual students with the lockers built into and flush with the interior hallway's walls. The lockers are at once individual but yet part of a collective that runs the entire length of this long hallway and on both sides. The second story of this Unit mirrors that of the first floor. All walls are 2/3 height beige tile as seen in Unit B. Above that is painted plaster and sheetrock and the ceiling is acoustic tile.

Booker T. Washington High School

Name of Property

Caddo Parish, Louisiana

County and State

Unit D: Classrooms (Photos 9, 11-13, 22-24)

Exterior – This Unit is also two story, and features many of the same details as Unit C. However, Unit D is about half the length of Unit C. The northern and southern elevations match those on Unit C. The western elevation as seen in Photo 8 has a simple first floor central entrance capped by a flat awning. The second floor has an 8 lite metal window on the northern side with metal panel above and a centrally placed window with metal panel above and below it. Besides that, the rest of the elevation is a blank brick wall.

Interior – The function and look of Unit D is the same as Unit C – with classrooms on both sides – with the difference of the hallway being shorter. And its second story mirrors that of the first floor.

Unit E: Manual Training / Classrooms (Photos 8, 10, 13-15, 19-20, 43)

Exterior – This Unit architecturally reflects the larger school and features the three elements of brick-glass-metal. However, the windows as built in 1949 were not a continuous ribbon like on the other units, but rather single units of 6 lites each (see photo 8). This building originally housed Manual Training classrooms and shops. One modification to this building is on the north end where the large bay doors allowing vehicles to enter the building for perhaps auto mechanic classes – has now been bricked in and contains an individual door (see Photo 9). Although slightly different than Units C and D in terms of window placement, Unit E was original to the 1949 construction as seen in vintage construction pictures.

Interior – As the exterior of Unit E is slightly different from Units C and D so is the hallway. The hallway for Unit E is much narrower and the walls are not finished surfaces, but brick. The interior looks more industrial than the other two classroom units and fitting so since it reflects the original purpose that of providing manual or vo-tech training to students. And today, Unit E serves essentially the same function.

Unit F: Walkway (Photos 15, 19, 20, 21, 22) – unlike the other hallways within the other five units which are clearly interior, Unit F is an awning covering the large sidewalk connecting Unit D with Unit E. The 1963 Sanborn map shows that it was original to the building and was always labeled as its own separate unit. Its width matches that of the primary hallway of Unit B from the entrance to the rear doors. However, it should not be underestimated as a style feature of the building. As the new library and new gymnasium were built away from the original building, they were connected by sideways with covered awnings that reflect Unit F. It is constructed of simple concrete columns, painted maroon, with a flat roof above.

3. Non-Contributing Resources

Booker T. Washington High School is comprised of the six original units (Units A, B, C, D, E, and F) constructed in 1949 and taken together under one roof, these Units form the one contributing resource on the property. However, on the 33 acres of the campus, there are several buildings, sites, and structures built outside the period of significance and are non-contributing. All non-contributing resources were built after the period of significance. There are no historic non-contributing resources.

Lakeside Branch Library (1949) (Photos 27, 28, 32)

Although built within the period of significance, this building was owned and operated by Caddo Parish under its Shreveport Memorial Library System and does not directly relate to the significance of Booker T. Washington High School. It may be eligible on its own as it was the first library for African Americans, but it does not directly relate to the school itself historically. It was given to the Caddo Parish School Board (CPSB) after the end of the period of significance when the library

Booker T. Washington High School

Name of Property

Caddo Parish, Louisiana

County and State

component moved to a different location. It was donated to a BTWHS Alumni association by the CPSB. This one story building was constructed at the same time as BTW HS in 1949 and has had no additions and one renovation in 2000. The brick veneered building has steel framed windows. The roof is standard asphalt roof shingles. HVAC sits on the ground and consists of a single unit protected by partial fencing. The interior is one open space with cabinets and folding tables. The structure is approximately 800 to 1000 square feet. The design of the building is certainly a modern design with a ribbon of windows on the western part of the façade facing Milam Street. The front entrance features a single door with multi lite windows surrounding it. It appears that the roof has been slightly altered from a flat roof to a low pitch, likely due to roof leaks common with flat roofs.

BTW HS Football Stadium and Football and Track Fields (1967) (Photos 17-18, 30, 33)

The 37,000 square foot, 10,000-seat stadium structure has not been modified since its original construction and stands approximately two-stories. It houses the headquarters for the BTWHS ROTC with classrooms, a shooting range, athletic locker rooms and showers, coach's offices, boiler room, equipment and first aid rooms, and additional storage. The football field in the middle of the stadium is natural turf with metal goal posts on its north and south axis, with a scoreboard at the northern axis. The 31,680 square foot oval track structure circling the football infield is approximately one quarter mile and is made of natural soil. Sitting on the southwest side of the structure is a one room In-School Suspension metal temporary structure which was added after the initial construction of the stadium. The football stadium is a non-contributing structure as it was constructed outside of the period of significance.

BTW HS Baseball Field (1967) (Photo 17)

The baseball field is a flat structure made of natural turf. At 81,000 square feet, it has had no renovations or additions. The field has the normal wire fencing backstop behind home plate with wire mesh dugouts. There are two sets of metal bleachers. The baseball field is a non-contributing site as it was constructed outside of the period of significance.

BTW HS Tennis Court (1967) (Photo 16)

The 16,280 square foot tennis court is an athletic structure with hard paved surfaces. It has been reconditioned to have four basketball goals on poles sharing the same paved surface with one tennis court to accommodate an outdoor basketball / tennis court with a partial fence surrounding it with openings for entry. The tennis court is a non-contributing site as it was constructed outside of the period of significance.

BTW HS New Library (1972) (Photos 5, 6, 9, 13)

This one-story library building replaced the original library which was inside the main entrance. It is composed of brick walls pierced by vertical windows with solid panels above and below the glazing. The library building is approximately 1500 to 2000 square feet. This new library is situated at the north end of Unit C between Units C and D. This new construction does not touch the original building and is connect by a covered sidewalk. It cannot be seen from the front of the building thus does not take away from the historic context of the original 1949 building. The new library is a non-contributing building as it was built outside of the period of significance.

BTW HS New Gymnasium (2006) (Photos 28, 29, 32)

The BTWHS new gymnasium contains 20,800 square feet. Its bowstring truss roof angles downward toward masonry walls and to a concrete base. It has had no additions and no renovations. It is used for grades 9-12 gym, basketball games, and special events. The building stands approximately two

Booker T. Washington High School

Name of Property

Caddo Parish, Louisiana

County and State

stories and is connected to the main school building by connecting sideways with covers. The new gymnasium is a non-contributing building as it was built outside of the period of significance.

Storage Building (circa 1970) (Photos 10, 14, 15, 19, 20)

This one storied brick building is next to but separate from Unit F. It does not reflect any element or architectural style used in the original school and has no windows. It has a pitched roof and large cargo doors. It is speculated it was built strictly as a storage area. The storage building is a non-contributing building as it was constructed outside of the period of significance.

CONCLUSION (to Non-Contributing Resources)

All ancillary buildings have been designed to mimic the original BTW design, materials, and look and feel of the campus retaining the original "park" landscaped design of the campus, but yet, all are clearly viewed as later construction. Any citizen or alumni familiar with the campus as originally constructed would easily recognize BTW HS regardless of the non-contributing resources now on the campus. Notwithstanding this handful of modern buildings and structures described above added to the 33 acre property, the distinctiveness of the original building's footprint; the architectural style as built in 1949 that ties all elements together; and the thoughtful blend of natural contours and man-made buildings all conspire to make Booker T. Washington High School eligible for listing on the National Register of Historic Places.

Alterations, Mitigation of Alterations, and Discussion of Integrity

Mitigation of Alterations

For the original 1949 building there are three discernible alterations. As mentioned for Unit A, the original windows on the eastern side, at the new administrative offices, have been replaced by a small addition with a ribbon of glass block windows. However, the similar size window opening as in 1949 was respected and when approaching the main entrance of the building it is not distracting. Comparing historic photos to the current appearance, one can easily recognize the school. Another alteration was in Unit E with the replacement of the bay doors for a shop classroom with an individual normal size pedestrian door. Unless looking for this feature, the replacement brick blends into the original wall. Lastly, there was a small addition made to the band room as pointed out in the discussion of Unit A. Window replacement has been very minimal on the school as a whole with the only noticeable replacements being done on the gym. Even these were done within the original opening and industrial style windows were used, respecting the original design of the building.

Integrity

The built integrity of Booker T. Washington High School reflects its significance – not only in architectural terms but also in community development. A student who attended the school when it first opened in January 1950 would today feel at home with the original building as it is today. This visiting former student could find the very classrooms where they experienced quality education and walk the halls where they once strolled thinking that time was limitless. Its function upon opening in 1950 was education of African Americans. Today the function of BTW HS remains education and while it is an integrated school, the student body remains majority African American.

In terms of the seven aspects of integrity, its location, setting, feeling, and association have not changed. It naturally fits on the same hilly contours as the architects designed and built it in the late 1940s and after these many decades, it still retains an awe factor in its masterful setting. It is associated with African American education and has not faltered in this quest since 1950 when it opened its doors to the first students. The feel of the original building has not been altered; a former

Booker T. Washington High School
Name of Property

Caddo Parish, Louisiana
County and State

student from the 1950s could relate to the educational and academic activities of today students attending BTW HS. Its integrity of design using the three elements of brick, glass and metal remains today as it was in 1950 when it first opened and was heralded as a an innovative building. Its integrity of materials remains high with only minor replacement of original materials having occurred over the last 65 years. The integrity of workmanship is also intact.

The building was built to last and it simple design and use of brick and metal throughout the building seems to make it ageless. Its association with education – especially of African Americans – has not changed and it became a symbol of the struggle of civil rights in Shreveport.

Conclusion

Booker T. Washington High School was and still is an integral part and place for the African American community in Shreveport. It is a symbol of history at several levels. Numerous graduates of BTWHS have become prominent educators, doctors, lawyers, politicians, business professionals, writers, and others noted in an array of professions. The school itself represented more than just obtaining a secondary level education. Place matters and the administrators, faculty, student body, and graduates have kept Booker T. Washington a place of education and of pride since 1950. Because of its high degree of integrity, Booker T. Washington is eligible for listing on the National Register.

8. Statement of Significance

Applicable National Register Criteria (Mark "x" in one or more boxes for the criteria qualifying the property for National Register listing.)

X	A	Property is associated with events that have made a significant contribution to the broad patterns of our history.
	B	Property is associated with the lives of persons significant in our past.
	C	Property embodies the distinctive characteristics of a type, period, or method of construction or represents the work of a master, or possesses high artistic values, or represents a significant and distinguishable entity whose components lack individual distinction.
	D	Property has yielded, or is likely to yield, information important in prehistory or history

Criteria Considerations:

	A	Owned by a religious institution or used for religious purposes
	B	Removed from its original location
	C	A birthplace or grave
	D	A cemetery
	E	A reconstructed building, object, or structure
	F	A commemorative property
	G	Less than 50 years old or achieving significance within the past 50 years

Areas of Significance (Enter categories from instructions.):

Period of Significance: 1949, 1949-1965

Booker T. Washington High School

Name of Property

Caddo Parish, Louisiana

County and State

Significant Dates: 1949, date of construction; 1950, beginning of classes; 1963: civil rights demonstration on campus

Significant Person (Complete only if Criterion B is marked above): N/A

Cultural Affiliation (only if criterion D is marked above): N/A

Architect/Builder (last name, first name): Flaxman, Theodore A. and Van Os, Seymour

Period of Significance (justification): A: Education - Begins with construction in 1949, opening on January 23, 1950 and continues to 1965, the present 50 year cutoff. Even after 1965 to this very day, the school continues to serve primarily African American students in Shreveport with an acknowledged distinguished heritage and tradition firmly based on the human spirit of achievement and the solid physical structure of the still intact original five units of the school building. A: Ethnic Heritage: Black – 1963 reflecting the date of the Civil Rights demonstration on the school's campus.

Criteria Considerations (explanation, if necessary): N/A

Statement of Significance Summary Paragraph (Provide a summary paragraph that includes level of significance, applicable criteria, justification for the period of significance, and any applicable criteria considerations.)

Booker T. Washington High School (BTWHS), located in Shreveport in Caddo Parish, is eligible for the National Register at the local level of significance under Criterion A: Education and Ethnic Heritage: Black for its role in educating Shreveport and Northwest Louisiana's African American Community for the last 65 years and for its role within the Civil Rights movement in northwest Louisiana in 1963. The school's construction in 1949 and opening in 1950 marked a vast improvement in the quality of education and educational facilities available to the African American students of Caddo Parish and Northwest Louisiana. Additionally, Booker T. Washington High School played a significant role in a civil rights incident in 1963, which gained national and international attention. The nomination has two periods of significance: 1949-1965 under Education and 1963 under Ethnic Heritage, the date of the civil rights incident.

Narrative Statement of Significance (Provide at least **one** paragraph for each area of significance.)

The construction and January 23, 1950, opening of Booker T. Washington High School began a significant era in the history of African-Americans in Shreveport, Louisiana. It can be argued this building was the first real state-of-the-art school for African-American high school students. Beginning in the late 1940s and into the 1950s, Shreveport's population expanded and the city incorporated nine neighborhoods between 1949 and 1960. Due to the post-World War II baby-boom generation, the Caddo Parish School Board during this time expanded its school facilities by almost forty including both categories of additions to existing school buildings or new schools built from scratch. Booker T. Washington High School was in the latter category – new construction. Situated within a thriving African-American neighborhood, the style of architecture used a popular school layout used elsewhere in the city. The finger arrangement consisted of separate parallel wings with a courtyard or green space in between the wings. The style of modern architecture and building methods and materials were at the time state-of-the-art with Booker T. Washington High School replacing an older 1917 school for African-American students.

Booker T. Washington High School

Name of Property

Caddo Parish, Louisiana

County and State

The school was named in honor of Booker T. Washington, former slave who through education and perseverance became a modern African-American pioneer in formal education founding Tuskegee Institute in Alabama. Just like its namesake, Booker T. Washington High School in Shreveport was designed to provide formal higher education to African-American students in a modern educational environment. Not only did the school offer secondary or high school education, but it also had a "Manual Training" wing to offer vocational technical education. The school also provided college preparatory academic courses (and still does).

African-American students in Shreveport and even students from areas in Caddo Parish outside the city limits attended Booker T. Washington High School. It was the largest African-American high school in Caddo Parish. Physically set within the then largest African-American neighborhood within Shreveport, the building became more than just an academic center of learning.

It became a community icon and demonstrated that place matters. The school, which superbly fit into its surrounding Lakeside / Allendale community of African-American families, businesses, and places of worship, became a symbol of hope and change. It witnessed the visits of Dr. Martin Luther King, Jr. to the neighborhood's churches in the late 1950s as the birth of the Civil Rights Movement began in Shreveport. It became a center of peaceful demonstrations against segregation and most notably a dramatic confrontation with Shreveport Police on September 23, 1963, when the police in force entered the campus. This phenomenon was not isolated to just Booker T. Washington High School in Shreveport, but played out in other schools in the Southern United States during this era.

Criterion A: Education

Following the Civil War, the Federal Reconstruction Legislation had passed laws opening up public schools to all races and providing state and federal money for the operation of such schools. A Freedmen's Bureau agent in Caddo Parish that same year stated that local whites were bitter about blacks attending school and there were no whites who attended the mixed race school in Shreveport. Even though the 1868 legislation was in place, that does not mean that segregation was nonexistent; rather it was commonplace, as it would be for the next 100 years in Shreveport.

The 1898 Louisiana state constitution further cemented segregation as a way of life. A portion of the constitution required separate schools for whites and blacks. The separate schools for black students were far inferior to the schools for white students. By 1900, a typical school building was a single or small multiple room frame schools for its students. By the 1910s through the 1940s, the single and multiple room frame schools were being replaced with larger school buildings. Of these schools built for African American students, there are six that are listed on the National Register of Historic Places, including the Central Colored High School in Shreveport. Others include "training schools" like the Bossier Parish and Webster Parish Training Schools. These were set up to help teach industrial and vocational skills as well as teacher training.

In Shreveport, the only secondary schools for African Americans prior to 1949 were Central Colored High School and the Milam Street Trade School. Central was built in 1917 and opened on September 23. Until Booker T. Washington High School was built in 1949, this was the only high school for African American students. It served both students who lived in the city as well as rural students who boarded with relatives residing in the city. Consisting of three brick buildings and three frame ones, the school taught basic courses in English, history, math, and geography. There was not much emphasis put on the social sciences, music, or art. The school went through the 11th grade.

Booker T. Washington High School

Name of Property

Caddo Parish, Louisiana

County and State

Operating in conjunction with Central was the Milam Street Trade School, built in 1939. It opened across the street from Lakeside Park, where Booker T. Washington High School would be built ten years later. Started as an experiment by the Caddo Parish superintendent, the school provided vocational training, like the parish wide training schools, for young African American students prior to finishing high school. Students from Central were required to take one year of vocational training, usually during their 10th grade year, in some type of vocation at Milam Street Trade School.

Courses at Milam Street included beauty culture, home economics, carpentry, shoe repair, rug weaving, and general domestic arts. In addition to serving the Central students, Milam Street also had house wives and elementary students enrolled in some courses. Following World War II, a special high school for black veterans operated at the school as well.

When Booker T. Washington High School opened in 1950, it took the place of Central Colored High School and the Milam Street Trade School. Central and Milam Street both became Junior Highs. Central is still standing today and operates as an elementary school while Milam Street, which closed in 1955, has since been demolished. The principal from Central became the first principal at Booker T. Washington High School.

Booker T. Washington High School

The new schools for African American students of the 1950s, like Booker T. Washington High School, were a result of the wide disparity seen between previous black and white schools. Previous surveys done of the African American schools described them as deplorable and that construction of a new high school would be one step towards improvement. Based on these surveys, great strides were made in the construction of quality school buildings for African American students. In addition to this survey, the Central Colored High School and Milam Street Trade School were woefully overcrowded at their current locations. Thus, the Booker T. Washington High School was built across the street from the Milam Street Trade School.

The very site of the state-of-the-art BTW HS was within 71 rather hilly acres containing a former park and golf course named Lakeside Park owed by the City of Shreveport. The City declared this property "abandoned" in 1946 and that year, sold 33 acres on the eastern side to the Caddo Parish School Board for the construction of a new high school to be named, Booker T. Washington. The hilly terrain provided a challenge to the architects designing the first modern high school for African Americans in Shreveport.

The other 38 acres became the Lakeside Municipal Golf Course which officially opened on December 1, 1952, some two years after the school had opened its doors to the first African American student. The Lakeshore Municipal Golf Course was the first course to open for African Americans in Shreveport and Northwest Louisiana (and it was added to the National Register in June 2005). It should be noted, the Lakeshore course has essentially kept its 1952 configuration, features and appearance – much like BTW HS had done during its 65 years of existence.

The school opened on January 23, 1950, and was considered a model school even for many white communities. It was also considered state-of-the-art at the time and some even called it one of the best built schools for blacks in the country. The total cost was \$1.5 million for the buildings and \$500,000 for the equipment. Innovations found at the school included individual lockers for all students, central heating, movable desks, modern labs, administrative offices, asphalt tile floors, and fluorescent lighting.

Booker T. Washington High School

Name of Property

Caddo Parish, Louisiana

County and State

To prove how state-of-the-art the school was considered, one can cite *LIFE* Magazine's October 16, 1950 article entitled, "US is Building Some Fine Ones but is Facing a Serious Shortage," which describes schools all over the country being built, including Booker T. Washington High School in Shreveport (see Figure 16). The article states:

Elementary schools like Blythe Park, Carmel, and the rest can use simple, one-story structure to great advantages. But big high schools and college buildings have more complicated architectural problems, for they must shelter relatively huge amounts of personnel and equipment. These are now going in for the sensible, industrial-looking, factory type of building. This approach is well expressed by the new Booker T. Washington High School for Negroes in Shreveport, LA. It needs shops and workrooms for its 1500 students and contains these handsomely and efficiently."¹

The article discussed schools throughout the country, including those from states like California, Texas, Connecticut, and Pennsylvania, but the only school chosen to represent Louisiana was Booker T. Washington High School in Shreveport.

The schools constructed in the 1950s in Louisiana, especially for black students, were radically different from what was experienced before this decade. These schools were of very modern designs and it can be argued, Booker T. Washington High School built in the late 1940s and opened in January 1950, set a standard for the rest of Louisiana to follow. For the African American community in Shreveport and in northwest Louisiana, BTW HS was a harbinger of historic significance.

The school offered basic high school and college prep academic courses in English, literature, music, social science, health, general science, biology, algebra, geometry, chemistry, and physical education as well as numerous vocational courses to supplement the work that had been done at Milam Trade Street School. These vocational courses included: commercial baking, laundry and dry cleaning processes, typing, shorthand, and bookkeeping, auto mechanics, masonry and cement work, graphic arts, horticulture, electrical mechanics, sheet metal working, pottery and clay, landscape gardening, leather craft, home laundry, cooking, sewing, needle craft, shoe craft, and beauty culture.

When BTW HS was opened in 1950, enrollment was 1,689 students in a school built for 1,500. This number didn't take into account the rural students who had not registered yet. Despite the beautiful new facility, there was still a lack of film, paper and pencils, up to date books, video and audio material, and other equipment normally found at a white school. Six years later, this overcrowding problem was alleviated some with the construction of two rural high schools – Walnut Hill and Herndon. Each had an enrollment of over 1,300; one can only imagine what the addition of this many rural students to BTW HS must have been like. BTW HS was thus Shreveport's only public secondary school for African American students.

Additionally, the only library for African Americans was built in 1953 next to BTW HS – Lakeside Library - and the building still stands today as the Booker T Washington Heritage and Cultural Center.

The Architects

Architecturally, it is unique, but also simultaneously fitted into the pattern of architectural styles being constructed on a wider scale in Shreveport, Louisiana. Two noted architects, Theodore A. Flaxman and Seymour Van Os forming the Van Os Flaxman Architecture firm, designed Booker T. Washington High School. Both were important modernist style architects in Shreveport.

¹ "New Schools: US is Building Some Fine Ones but is Facing a Serious Shortage." *Life*. 16 October 1950: pg 86

Booker T. Washington High School

Name of Property

Caddo Parish, Louisiana

County and State

In the state of Louisiana, Shreveport was the leading urban area with the most modernist buildings in terms of number and Booker T. Washington High School contributed to this built heritage. The modernist style was the results of architects in the United States and Europe to create a unique architectural style reflecting the 20th Century. These two Shreveport architects combined their experience in local traditional styles using elements of international and modern styles from Europe to create modernist buildings in Shreveport. Specifically, Van Os uniquely blended traditional and art deco elements with modernist elements with many of buildings from both architects still standing today and listed on the National Register of Historic Places. A sampling of their architectural style in Shreveport with the year of construction includes:

- the Masonic Temple (1937) by Flaxman
- Agudath Achim Synagogue (1938) by Van Os
- Municipal Auditorium (finishing work in early 1930s) by Van Os
- B'nai Zion Temple (1956) by Flaxman and Van Os.

Individually and collectively, these architects brought their experience and expertise to the design of Booker T. Washington High School. The building was built for just over \$1.5 million dollars and upon its opening, became the most modern high school in Louisiana. For the era of construction, it contained innovative features including individual lockers for students, modern laboratories and a central heating system. When constructed, Booker T. Washington High School was the second largest school by size in Caddo Parish. Fortunately, the school today maintains its architectural integrity although thousands of students have passed through its corridors and into the world to chart their paths through life with distinguished careers.

From the date of its construction in 1949 and opening in 1950, until the present day, Booker T. Washington High School has educated Shreveport's African American students in a facility that was part of an overall movement for more equalized educational facilities. It took over where Shreveport's previous African American schools left off, combining both traditional educational courses and vocational courses into an all-encompassing high school that has produced who have become prominent educators, doctors, lawyers, politicians, business professionals, writers, with others noted in an array of professions. The school changed the trajectory of education for African Americans in northwest Louisiana by bringing a cohesive order to educational coursework and school architecture.² The schools dictum – Honor-Knowledge-Loyalty – remains true today for each graduate as it did for the first graduate over 65 years ago. And the physical footprint of the school itself has kept its historic integrity and architectural authenticity the same for 65 years.

Criterion A: Ethic Heritage-Black

Booker T. Washington High School played a very important role in the Civil Rights activities in Shreveport during 1963 when a group of students organized themselves in protest of the beating of Reverend Harry Blake and were confronted and attacked by local police. Their resolute stand against the inhuman treatment of Rev. Blake and others was a significant moment in Shreveport's Civil Rights movement. The police reaction and presence on campus as seen in Figures 11 and 14 impacted students and was seen throughout the nation. In addition to the school's role in this one incident, it also served as a gathering and meeting place for other marches throughout the 1960s.

The school had also been involved in the Civil Rights Movement in other ways prior to the incident in 1963 as well as after, when students from the school had been arrested for promoting desegregation

² Edgar Rogers, National Register draft nomination, 2011, section 8, pg 12.

Booker T. Washington High School

Name of Property

Caddo Parish, Louisiana

County and State

by passing out hand bills in 1960, with the burning of crosses on the school's campus by whites opposing integration of Louisiana's public schools in New Orleans, and by serving as a meeting and gathering place for NAACP marches in 1968, to name a few.

The Civil Rights movement in Louisiana and in Shreveport parallel each other, but also differ. It is not lost in history that the last Confederate state capital to capitulate to Union forces after the Civil War was located in Shreveport. This was not due to the fact that the city itself was a bastion of holdouts, but more so due to geography. Shreveport, in the northwest corner of Louisiana, was some distance away from the more populous south Louisiana with its bigger population and the largest Southern city in the antebellum United States, New Orleans. From the Civil War and its aftermath through Reconstruction, the struggle by African Americans for full and complete equal rights began in Louisiana as in other former Confederate states. From roughly the end of Reconstruction in 1877 until World War II, Civil Rights ebbed and flowed. Post-World War II America with its millions of war veterans, including African Americans, saw the Civil Rights themes become undeniable.

With the removal of Federal troops from the state in 1877 and the election of Democrats known as "Redeemers," who sought to remove any changes created by Reconstruction and any ideas of racial equality, the African American residents of Caddo and Bossier parishes in the Northwest corner of Louisiana began to look for new solutions to their situation. They knew that the lives of African American agricultural workers in these parishes was not much different post-Civil War than it had been under slavery and after trying to come up with ways to address the problem in state, they soon realized that the only hope for them was to leave the state. Thus, they began to advocate for emigration to Kansas and many of these people did end up leaving and resettling on the prairies of the central United States. This example of foreword thinking shows that life following Reconstruction for African Americans was quickly disintegrating to be similar to the way it was prior to the Civil War.

In 1890, the state of Louisiana passed legislation requiring separate accommodations for black and white passengers on train cars. Two years later, Homer Ferguson, a light skinned black man, attempted to sit in the white section of a train car and was arrested. He filed a lawsuit and in his case, *Plessy v. Ferguson*, in which he lost, he stated that his arrest was a violation of his 13th and 14th Amendment rights. Plessy appealed the case and it made it all the way to the United States Supreme Court where the high court ruled that the state of Louisiana had not violated his rights. This set in motion the "separate but equal" precedent that would be prevalent in strangling African American rights for the next 60 years and impact on education for African American children.

Perhaps just as crippling was the new 1898 Louisiana state constitution which quashed African American voting rights as well as required separate schools for white and black students. Following the passage of the constitution, the number of African American voters was around 5,000, when just ten years earlier, it had been over 120,000. Over the next fifty years, some progress was made throughout the state by African Americans, including in Shreveport, primarily through activities within their own communities. However, the iron fist of Jim Crow was not kind to the African Americans of Louisiana and made progress a very slow process.

In the first decades of the 20th century, Shreveport developed into an oil center. It had been acknowledged much earlier as a regional hub of the Red River valley, but was not booming due to oil. While it was the second largest city in the state at the time, it was still a very insular community that had few ties to the Acadian or French culture of south Louisiana and was considered an ultra-conservative city, even within the context of the entire south. White supremacy reigned. A local NAACP member in 1923 described Shreveport by saying, "This place is one of the most intolerant in

Booker T. Washington High School

Name of Property

Caddo Parish, Louisiana

County and State

the whole southland.”³ A journalist described it as having, “more hate per square inch than any city in the United States.”⁴ Finally, Alonzo B. Willis, who was the editor of the *Sepia Socialite*, an African American newspaper published from 1937-45 in New Orleans, wrote,

Shreveport was one of the prejudiced cities in the South....The Negro (in Shreveport) has been subjugated to the fears of white superiority from when, seemingly he cannot escape – police beat them at will – they are treated like economic parasites by white business—(and) are afraid to protest against the many injustices heaped upon them.⁵

One way that whites terrorized the black community was through lynching. Between the years of 1900 and 1931, 19 blacks were lynched, which was more than any other Louisiana parish. One case, in particular, helps to show the fear held by African Americans (for good reason) and the harsh treatment by whites. In 1946, Albert Harris and John C. Jones, ages 17 and 18 respectively, were arrested on suspicion that they had looked in a white woman’s window while she was home alone. She did not get a good look at the man she saw in her yard, but yet, these two teenagers were still arrested based upon the fact that her husband said they were acting funny. The teens were later charged by saying that one served as lookout while the other peered into the house – yet, the woman says she only saw one African American man in her back yard. Nonetheless, once the teens were in custody, they were beaten with rubber hoses for hours in order to get a confession out of them, which never happened. They were released later that weekend and told there were no charges being brought. However, once they got outside of the jail, two cars and five white men were waiting for them. The men took the teenagers out into the woods and beat them and left them for dead. Harris survived, but John C. Jones, a World War II veteran, did not. In the ensuing trial, the two sheriff’s deputies who were arrested for Jones’ death were acquitted by an all-white jury. As unjust as this case was, it was not uncommon throughout the American South during the period leading up to the Civil Rights Movement.

As with many other parts of the south and the country as a whole, with the return of African American World War II veterans, like John C. Jones, civil rights activism received a boost in the late 1940s. African American citizens, especially those who had served in military uniform during the war, had bolstered dreams and began to push for the full rights of citizenship in public accommodations, education, and all aspects of life.

With the passage of *Brown vs. the Board of Education* in 1954 and segregation declared unconstitutional, it appeared briefly that life may change for African American students throughout the state. However, many African Americans did not have confidence that anyone would actually enforce this new law. The State of Louisiana did all it could to circumvent the decision and to slow down integration and the progress of civil rights. In 1957, Governor Earl K. Long signed a bill giving him the power to close public schools threatened with integration. Along with this portion of the bill, others sections repealed a state law requiring bus and trolley segregation, but gave the first passenger in a row of double seats the right to say who sits next to them. This bill also essentially forbade the NAACP by outlawing associations engaged in school, education, or political activities from affiliating with similar out of state organizations (i.e. NAACP, CORE, SCLC, etc.) with a record of communist affiliations on their board of directors.

³ Adam Fairclough. *Race & Democracy: The Civil Rights Struggle in Louisiana, 1915-1972.*, pg. 8

⁴ Ibid. pg. 330.

⁵ Willie Burton. *The Blacker the Berry...A Black History of Shreveport*, pg. 148.

Booker T. Washington High School

Name of Property

Caddo Parish, Louisiana

County and State

The Shreveport chapter of the NAACP, which struggled through the 1940s and 1950s had only five official members in 1950. The ban of the NAACP in 1958 also required the group to provide the state legislature with a list of its members, which of course, it did not do. The struggles faced by the Shreveport NAACP chapter during this time and leading up to the 1958 ban would lead to the formation of another local Civil Rights organization, the United Christian Movement.

Formed in 1957, the United Christian Movement (UCM) was formed by ministers and a dentist, Dr. C.O. Simpkins. Dr. Simpkins was also a close associate and friend of Dr. Martin Luther King, Jr., and served as a board member of the Southern Christian Leadership Conference (SCLC). This close association, as well as close friendships with Reverend Harry Blake brought Dr. King to Shreveport many times during the late 1950s into 1960s. Because of this close friendship between Dr. King and Simpkins and Blake, the two Shreveport men were often harassed, threatened, and attacked.

The general goal of the UCM was to encourage, promote, and obtain complete and first class citizenship in all sections of the United States of America. Their first act was to ride a trolley bus and challenge the segregation of public transportation. The ministers boarded the bus and sat in the front seats for a 45 minute ride. They were not harassed and only had one white person refuse to get on the bus. The ministers were not arrested due to the orders of Mayor James Gardner. However, this did not mean that the UCM ministers had ended the segregation of the buses. Mayor Gardner made it clear that if any future rides were planned, he and the police would enforce state segregation laws and future violations would not be tolerated.

The local newspaper in Shreveport wanted the city to enact an ordinance for public transportation like one enacted in Tallahassee, which allowed individual drivers to assign seats on an individual basis, further perpetuating segregation. By the fall of 1957, there were more trolley rides tried by African Americans who refused to move to the back of the bus. However, Mayor Gardner kept his promise and one woman, Mrs. Frances Sullivan, was arrested for refusing to move from a "white" seat. The UCM filed a suit following Mrs. Sullivan's arrest seeking an injunction against the city's enforcement of state statutes requiring segregation in public transportation. No ruling was ever made on the case as in 1958, the Louisiana legislature was required by the Federal government to repeal trolley segregation laws. One would think this would signal an end to bus segregation. However, the legislature passed laws that allowed operators of public transportation to assign seats for the safety of other passengers as well as the other segregationist laws discussed above (abolishing the NAACP, etc.). The federal suits filed by the UCM were dismissed by the judge who did everything he could by issuing stays to slow down the desegregation process. By 1962, the UCM was defunct, but their impact and legal work remained so that by 1963, African Americans in Shreveport could ride public transportation without being molested.

While progress was made in public transportation, large scale progress in civil rights was slower. The African American community was generally slow to respond to calls for direct action because of the constant police repression and harassment. Those who did respond were often arrested and jailed on charges of vagrancy. Perhaps the most impactful was the work of the Shreveport Commissioner of Public Safety, George D'Artois, who made it very clear from the first day on his job that he would not tolerate civil rights demonstrations.

Prior to D'Artois' reign as Public Commissioner, civil rights workers had tried to participate in activities that were occurring in other southern states. Freedom riders were arrested in August of 1961 at the Continental Trailways Bus Terminal in downtown Shreveport. Planning on boarding a bus in

Booker T. Washington High School

Name of Property

Caddo Parish, Louisiana

County and State

Shreveport and riding to Jackson, Mississippi, the Freedom Riders were arrested when they entered a white waiting room. Police and sheriffs had been at the station waiting for them.

Later that same year, on October 9, activists were having a "Freedom Dinner" at St. Rest Baptist Church when two Molotov cocktails were thrown into the sanctuary. Police attempted to arrest 16 CORE (Congress of Racial Equality) members for the crime even though one of these members witnessed two white males in a car and truck throw the bombs into the church from the parking lot.

The Year 1963 marked the time in the Shreveport Civil Rights Movement began to really take off even though Commissioner D'Artois had issued a blanket ban on picketing, marches, and direct action making organizing and protesting a difficult task. Numerous sit-ins and other forms of demonstrations were held at Sears, H.L. Green, Woolworth's, Walgreen's, and Kress, resulting in many arrests in these downtown stores. On July 19, 1963, sit-ins simultaneously held at Woolworth's and Walgreen's resulted in the arrests of several teenagers. They had been asked to leave the stores by the owner, which they had done, but they were still arrested down the street after they had left. In addition to the teenagers' arrest, known adult leaders of the movement were also arrested for the demonstrations.

September 1963

On September 17, 1963, four young African American girls were killed in a bombing at 16th Street Baptist Church in Birmingham, Alabama. This tragic event rocked the nation and directly impacted what would happen in Shreveport one week later. September 22nd would mark one of Shreveport's most notorious days for racial intolerance. The Shreveport NAACP chapter, headed by Reverend Harry Blake, and the Interdenominational Ministerial Alliance planned a memorial parade for the four girls starting at Booker T. Washington High School and ending at Little Union Baptist Church. A march permit was applied for, but was denied by D'Artois, who promised to "enforce the laws of the city and state regardless of a few individuals who want to destroy our American way of life."⁶ Reverend Blake, interviewed in 2009 for an article in *The Shreveport Times*, said:

What I really planned to do was to call the march off, because I didn't want people to get arrested. He (D'Artois) said to me, if you have the march, we are going to arrest everyone who is participating in the march. So what we finally decided to do is that we would meet at the origin of the march – the designated origin – and say to the people, 'Get in the cars and just go to Little Union rather than marching.'⁷

The march went on as planned though and after it started near Booker T. Washington High School, roughly 500 attendees were at Little Union Baptist Church for the service. Photos and video footage from that day show large crowds around the church as well as many policemen in riot gear. Following the service is when the situation turned tense and violent. How the violence incident at the church began differs as some say people outside were throwing rocks at police (though witnesses deny this) or that it was started by police. But a firsthand description from Reverend Blake states:

At the end of the service, I believe the late attorney Jesse Stone went out to say to the commissioner (D'Artois), now the people need to come out of the service. Are you going to arrest them? He said, I will not if they come out in an orderly manner in twos. So while we were organizing them to exit, I went out of the vestibule of the church to see what was going

⁶ Fairclough, pg. 331.

⁷ Alexandyr Kent. "Civil Rights Then and Now: The Rev. Harry Blake." April 17, 2009.

Booker T. Washington High School

Name of Property

Caddo Parish, Louisiana

County and State

on because we heard a noise. Some of our youngsters were being beaten by the police. And as I entered the vestibule, the commissioner caught me and handed me over to two other policemen who began to beat me in the vestibule of the church. And then they brought me on the outside, and each policeman who could get a piece of my head with his nightstick began to beat me. When I appeared to be lifeless, nonresistant, they left me lay on the grass. See the mistake he made was he hit me on the hardest part of my body, my head. Had he hit me anywhere else, I would have died.⁸

Blake was treated by a doctor friend in Shreveport at his home before being taken to a hospital in Dallas for further treatment. Mounted police broke up the crowd and the situation died down for the night.

The next day, Booker T. Washington High School students reacted. Not only had the school been the starting point of this march, it had been targeted in earlier years with burning crosses put on the campus by whites as well as students arrested for demonstrating near the school. On the 23rd of September 1963, the school become nationally known for the events that occurred there on that fateful day.

Around 200 students formed a group on the school's campus to protest the beating of Rev. Blake and others the previous night. At some point, they decided to march downtown (police later accused adult leaders of the movement for organizing the march and protest, but it was planned solely by the students). About two blocks from the school, they were confronted by police in riot gear. The police fired tear gas into the crowd and began pushing the students back towards the school. Some of the police began to beat the students with nightsticks. Some students were taken and put into paddy wagons and police cars. The rest raced back to the school and retreated inside for safety. The police then attempted to enter the school, but were pushed back by students throwing whatever they could at the police. Teachers also tried to protect the students from the police and were arrested. A minister, who was inside of the school, eventually came outside and talked with Commissioner D'Artois, convincing him to pull his men back and allow the students to go home. The event was televised nationally and reported on by newspapers across the country (see Figure x for image from that day's events).

The next day a lunchtime rally was held by 700 African American students, including those as young as age 12, at J.S. Clark Junior High, near the Booker T. Washington campus. Commissioner D'Artois threatened to use tear gas to break up the demonstrations and send three African American police officers to break up the demonstration.

During the events of September 23, 1963, three BTW HS students were suspended – Charles Brown, Frank Daniels, and Calvin Evans – and 17 others were placed on indefinite probation. One month later, on October 23, over 1,800 students staged a silent protest by staying home on what was termed "Frank Daniels Day," protesting the suspension of the three BTWHS students.⁹ Mass civil rights meetings continued throughout the rest of 1963 held at various churches throughout Shreveport.

Conclusion:

Booker T. Washington High School's construction changed African American educational history by providing an incalculable effect on educational literacy for the African Americans of Caddo Parish and

⁸ Ibid.

⁹ Burton, pg. 184-185.

Booker T. Washington High School

Name of Property

Caddo Parish, Louisiana

County and State

Northwest Louisiana. It brought their educational experiences into the 20th Century through greatly improved facilities and learning opportunities. Additionally, the school's presence generated notable growth in the size and improvements in the living environment for Lakeside residents. Finally, BTW HS was also the site of a most significant and major civil rights event in Northwest Louisiana which gained national and international attention. The school itself symbolized more than just obtaining a secondary level education. Booker T. Washington High School became a symbol of hope and change. It witnessed the visits of Dr. Martin Luther King, Jr. to the neighborhood's churches in the late 1950s as the birth of the Civil Rights Movement began in Shreveport. It became a center of peaceful demonstrations against segregation and most notably a confrontation with Shreveport Police on September 23, 1963, when the police in force entered the campus. Thus, BTWHS fully meets the eligibility guidelines for National Register Criterion A. The school is a monument to the progression of the descendants of slaves into the 20th Century and is a model of courage regarding the community, educators, and the architects in the "segregated" South who sought its construction, built it, and maintained it.

Developmental History/Additional historic context information

School Desegregation and Integration

In 1964, the schools in Shreveport were still segregated. Racial integration had indeed occurred in public accommodations in Shreveport, but whites would not accept integration in schools. Even with the passage of the Civil Rights Act in 1964, which brought more federal government intervention, integration made barely any progress.

The Civil Rights Act had authorized the Department of Health, Education, and Welfare (HEW) to withhold Federal funds from school districts that failed to submit desegregation plans. However, federal pressure sadly did not have much effect in Louisiana. By 1965, only five parish school boards had submitted voluntary plans. Most refused to submit a plan at all. The Caddo Parish school board stated that its job was "to provide children with the best education possible."¹⁰ The school board felt that it was already doing just that and because of that, was not discriminating against black students. The normal plans instituted by these school boards became known as "freedom of choice" plans whereby parents had a theoretical right to send their children to either a previously all white school or previously all black school. In effect, this meant that the decision to integrate was essentially left with black parents.

In 1965, following the decision to implement "freedom of choice" plans, Arthur Burton and Brenda Braggs became the first black students to attend a white school in Caddo Parish when they integrated Byrd High School. Statistics from later that year show that 577 black students sought admission to white schools, no white students applied to formerly all black schools, and 51 black students who had attended a previously all white school the year before, now requested to transfer back to a formerly (and still) all black school.

Four years later, the 5th Circuit Court pointed out that 90 percent of the black children in 29 districts in Louisiana still attended all black schools. In Shreveport and Bossier City, there were no white children attending anything other than all white schools. After learning this, the 5th Circuit Court ordered all school boards to prepare new plans within 30 days, paying close attention to HEW's guidelines. HEW also drew up recommendations for each school district and if the school boards refused to submit a new plan, HEW's recommendations would be automatically enforced.

¹⁰ Fairclough, pg.437.

Booker T. Washington High School

Name of Property

Caddo Parish, Louisiana

County and State

This decree was met with disdain and contempt and the reaction in Caddo Parish was as expected. The Caddo Parish School Board unanimously rejected HEW's recommendations and attempted to keep "freedom of choice" intact. They adopted an open enrollment plan that assigned children to the school of their choice within a given geographic zone. This plan ensured that "no child of either race will be forced....to attend a school in which the opposite race is in the majority."¹¹

By 1970, Caddo Parish Schools were still not fully integrated. The school board was ordered to restudy their geographic zones and it was found out that many white students, who were within the geographic zone for schools such as Booker T. Washington High School, were attending schools that were not within their geographic zone. Suits were filed against the school board charging them with failing to implement a court ordered nondiscriminatory, unitary school system. By the mid-1970s, attempts were made at keeping 50/50 ratios of black and white students and teachers at some schools. More black students began to attend formerly all-white schools, which in turn led to increased white flight from those same schools. It wouldn't be until 1979 that the 5th Circuit Court would enter a ruling declaring that the Caddo Parish School system was unitary.

The NAACP in Shreveport in the 1960s

In 1968, B.J. Mason was elected president of the Shreveport NAACP chapter, which led to a revival for the branch. He was a 24 year old graduate of Grambling College (now Grambling State University) and a writer who worked part time for the *Shreveport Sun*, a local African American newspaper. One of Mason's main goals when he took the reins of the chapter was to challenge the ban on picketing and demonstrations instituted by Commissioner D'Artois. Mason presented plans to D'Artois to improve police and community relations and to his surprise, D'Artois actually implemented some of the ideas.

Mason also organized many marches and pickets, including one at Stan's Record Shop on Texas Street in downtown Shreveport, a store that catered to black patrons, but also carried racist titles in its stock. The police did not arrest any of the picketers marking the first time in the history of Shreveport's Civil Rights Movement that this had happened.

Mason also formed a Youth Council, which demonstrated and planned many marches, most of which began at Booker T. Washington High School. Some of these marches, including one on September 18, 1968, were attended by thousands of youth. No Youth Council members were arrested or harassed during their marches, which was another victory for the Shreveport movement. Mason resigned from his position in 1969, but got many positive goals accomplished in his year of service to the NAACP chapter in Shreveport.

9. Major Bibliographical Resources

Bibliography (Cite the books, articles, and other sources used in preparing this form.)

A Pictorial History of Northwest Louisiana, The Early Years, Vancouver, Washington, Pediment Publishing, 2000

Blokker, Laura E. "The African American Experience in Louisiana." *Louisiana Division of Historic Preservation*. N.d. Web. 4 September 2014.

¹¹ Fairclough, pg. 441.

Booker T. Washington High School
Name of Property

Caddo Parish, Louisiana
County and State

[http://www.crt.state.la.us/Assets/OCD/hp/nationalregister/historic_contexts/The African American Experience in Louisiana.pdf](http://www.crt.state.la.us/Assets/OCD/hp/nationalregister/historic_contexts/The_African_American_Experience_in_Louisiana.pdf).

Brock, Eric. *Eric Brock's Shreveport*, Gretna, Louisiana, Pelican Publishing Company, 2001

Burton, Willie. *The Blacker the Berry...A Black History of Shreveport*. Shreveport, LA: Shreveport Times, 2002. Print.

Caddo Parish School Board Webpage. www.caddoschools.org/. Accessed April 1, 2015.

"Comprehensive Facility Assessment Report for Caddo Parish Schools: Final Report."
<http://www1.caddoschools.org/sites/2/files/Comprehensive%20Facility%20Assessment%20Final%20Report%206112010.pdf>. Accessed April 1, 2015.

Fairclough, Adam. *Race & Democracy: The Civil Rights Struggle in Louisiana, 1915-1972*. Athens, GA: University of Georgia Press, 1999. Print.

Flaxman, T.A., Architectural Records (Box 3, Folder 1), Special Collections, Noel Library, LSU-S, Shreveport, Louisiana

Kent, Alexandyr. "Civil Rights Then and Now: The Rev. Harry Blake." *The Shreveport Times Online*. April 17, 2009.

Kingsley, Karen. *Buildings of Louisiana*, Oxford University Press, Oxford, United Kingdom, 2003

"New Schools: US is Building Some Fine Ones but is Facing a Serious Shortage." *Life*. 16 October 1950: pg 86. Print.

Rogers, Edgar. National Register of Historic Places Preliminary Determination of Eligibility Questionnaire (June 24, 2011); author of 2011 nomination draft. Housed at Louisiana Division of Historic Preservation

Sanborn Fire Insurance Map (Shreveport), 1935-January 1963, Special Collections, Noel Memorial Library, LSU-S, Shreveport, Louisiana

Shreveport Police Department Photograph album (picture #63), Special Collections, Noel Library, LSU-S, Shreveport, Louisiana.

Previous documentation on file (NPS):

- preliminary determination of individual listing (36 CFR 67) has been requested
- previously listed in the National Register
- previously determined eligible by the National Register
- designated a National Historic Landmark
- recorded by Historic American Buildings Survey # _____
- recorded by Historic American Engineering Record # _____
- recorded by Historic American Landscape Survey # _____

Primary location of additional data:

- State Historic Preservation Office
- Other State agency
- Federal agency
- Local government

Booker T. Washington High School
Name of Property

Caddo Parish, Louisiana
County and State

- University
- Other

Name of repository: Special Collections, Noel Memorial Library, LSU-Shreveport

Historic Resources Survey Number (if assigned): N/A

10. Geographical Data

Acreage of Property: 32.13 acres

Latitude/Longitude Coordinates

Datum if other than WGS84: _____
(enter coordinates to 6 decimal places)

- | | |
|------------------------|-----------------------|
| 1. Latitude: 32.503593 | Longitude: -93.771745 |
| 2. Latitude: 32.503590 | Longitude: -93.775322 |
| 3. Latitude: 32.507062 | Longitude: -93.775323 |
| 4. Latitude: 32.507050 | Longitude: -93.773067 |
| 5. Latitude: 32.507166 | Longitude: -93.772937 |
| 6. Latitude: 32.507165 | Longitude: -93.771746 |

Verbal Boundary Description (Describe the boundaries of the property.)

The nominated property is bounded on the south by Milam Street, on the east by Holzman Street, on the north partially by Logan Street with the remainder as property line and on the west by the Jerry Tim Brooks Golf Course (City of Shreveport municipal property).

32.12 acres being E. 1100 ft of NE/4 of SW/4 of Sec 35-18-14, Less N. 49.06 ft of Lot 5 per assessors city play 181435-17-11. (Legal Property Description from Tax Assessor) – See imagery map for boundaries.

Boundary Justification (Explain why the boundaries were selected.)

The boundary of the nominated property includes all land historically associated with Booker T. Washington High School and its activities, as well as the old parish library/alumni center on the southeast corner of the property. The original 33 acres retains its rectangular shape and has been intact since 1950 as the site of the school.

11. Form Prepared By

name/title: William Lane Callaway, Commissioner and Chair
organization: Shreveport Historic Preservation Commission
street & number: 9677 Catawba Drive
city or town: Shreveport state: LA zip code: 71115
e-mail: wllcallaway@att.net
telephone: 318.402.3854
date: January 30, 2015

Additional Documentation

Submit the following items with the completed form:

Booker T. Washington High School

Name of Property

Caddo Parish, Louisiana

County and State

- **Maps:** A **USGS map** or equivalent (7.5 or 15 minute series) indicating the property's location.
- **Sketch map** for historic districts and properties having large acreage or numerous resources. Key all photographs to this map.
- **Additional items:** (Check with the SHPO, TPO, or FPO for any additional items.)

Photographs

Submit clear and descriptive photographs. The size of each image must be 3000x2000 at 300 ppi (pixels per inch) or larger. Key all photographs to the sketch map. Each photograph must be numbered and that number must correspond to the photograph number on the photo log. For simplicity, the name of the photographer, photo date, etc. may be listed once on the photograph log and doesn't need to be labeled on every photograph.

Photo Log

Name of Property: Booker T. Washington High School

City or Vicinity: Shreveport

County: Caddo

State: Louisiana

Name of Photographer: Jenn Wasserman of Neil Johnson Photo, Shreveport, Louisiana

Date of Photographs: March 29 and 30, 2015

- 1 of 52: Main façade of Booker T. Washington High School; camera facing north.
- 2 of 52: Left side of main façade, Unit C; camera facing northwest.
- 3 of 52: Right side of main façade, Units B and A; camera facing northeast.
- 4 of 52: Main façade of Unit C; camera facing northeast.
- 5 of 52: Western elevation of Unit C and the new library; camera facing northeast.
- 6 of 52: Western elevation of Unit C and the new library; camera facing southeast.
- 7 of 52: Western elevation of the new library, Unit D, and Unit E; camera facing northeast.
- 8 of 52: Western and southern elevations of Unit D and E; camera facing northeast.
- 9 of 52: View looking southeast towards Units D and C and the new library; camera facing southeast.
- 10 of 52: Western elevation of Unit E, the non-contributing storage building, and baseball field and football stadium in the background; camera facing east.
- 11 of 52: View of courtyard between Units D, E, and the new library; camera facing east.
- 12 of 52: View of courtyard area between Units D and E showing walkways between the buildings; camera facing east.
- 13 of 52: View of courtyard between Units E, D, and the new library; camera facing southeast.
- 14 of 52: View of Unit E; camera facing southeast.
- 15 of 52: View of the non-contributing storage building and the walkways between Units E and D; camera facing south.
- 16 of 52: View of the non-contributing tennis courts; camera facing northeast.
- 17 of 52: View of the non-contributing baseball field and football stadium/track; camera facing northeast.
- 18 of 52: View of the non-contributing football stadium/track; camera facing east.
- 19 of 52: View of Unit E, covered walkway, and the storage building; camera facing southwest.
- 20 of 52: View of covered walkway leading to Unit E; camera facing southwest.
- 21 of 52: View of covered walkway and Units D, A, and B; camera facing southwest.
- 22 of 52: View from under the covered walkway between Units D and E; camera facing south.

Booker T. Washington High School

Name of Property

Caddo Parish, Louisiana

County and State

- 23 of 52: View of covered walkway between Units E and D as well as exterior of Unit B; camera facing west.
- 24 of 52: View of Unit B from the parking lot; camera facing southwest.
- 25 of 52: View of Units A, B, D, and E from rear parking area; camera facing southwest.
- 26 of 52: View of Units B, D, and E; camera facing west.
- 27 of 52: View of main façade of old parish library/alumni building; camera facing north.
- 28 of 52: View from old parish library/alumni building looking towards the rest of the high school campus; camera facing northwest.
- 29 of 52: View of new gymnasium and the main school building; camera facing northwest.
- 30 of 52: View of new gymnasium and football stadium/track from southeast corner of the property; camera facing north.
- 31 of 52: View of new gymnasium; camera facing northeast.
- 32 of 52: View of old parish library/alumni building; camera facing east.
- 33 of 52: View of parking lot between Unit A's band room and new gymnasium; camera facing north.
- 34 of 52: View of Unit A and B; camera facing northwest.
- 35 of 52: Closer view of Unit A and band room addition; camera facing northwest.
- 36 of 52: View of Unit A's auditorium façade; camera facing northwest.
- 37 of 52: View of connection between Unit A and B; camera facing northwest.
- 38 of 52: View of main interior hallway in Unit B between Units C, D, and E; camera facing north.
- 39 of 52: View of hallway leading to Unit A from Unit B; camera facing east.
- 40 of 52: View of hallway in Unit C; camera facing west.
- 41 of 52: View of one of the main school building's original stairwells.
- 42 of 52: View of another of one of the main school building's original stairwells.
- 43 of 52: View of hallway in Unit E; camera facing west.
- 44 of 52: View of the cafeteria; camera facing southeast.
- 45 of 52: View of the "old", original, gym; camera facing southeast.
- 46 of 52: Second view of the original gym; camera facing northeast.
- 47 of 52: View of the hallway leading towards Unit A looking towards Unit C and the main hall; camera facing west.
- 48 of 52: View of the auditorium; camera facing east.
- 49 of 52: Second view of the auditorium; camera facing east.
- 50 of 52: Third view of the auditorium; camera facing east.
- 51 of 52: View of the auditorium as seen from the stage; camera facing west.
- 52 of 52: View of the band room; camera facing southwest.

List of Figures:

Figure 1: BTW HS Under-construction Aerial View ca1949-1950

Figure 2: BTW HS Under-construction ca1949-1950 (A)

Figure 3: BTW HS Under-construction ca1949-1950 (B)

Figure 4: BTW HS Under-construction September 1949 (Photographer: H.O. Wiseman)

Figure 5: BTW HS Finishing Construction September 1949 (Photographer: H.O. Wiseman)

Figure 6: BTW HS Finishing Construction ca1949-1950 (A)

Booker T. Washington High School

Caddo Parish, Louisiana

Name of Property

County and State

Figure 7: BTW HS Finishing Construction ca1949-1950 (B)

Figure 8: BTW HS Exterior View Front Elevation September 1950 (Photographer: William A. Bains)

Figure 9: BTW HS Main Entrance no date (Photographer: William A. Bains)

Figure 10: BTW HS Exterior View (from Milam Street) no date

Figure 11: BTW HS Shreveport Police on BTW HS Campus, April 23, 1963 (Photographer: Shreveport Police Department)

Figure 12: 1963 Sanborn Fire Map showing Booker T. Washington High School. Image courtesy of the State Library of Louisiana's Digital Sanborn Map Collection.

Figure 13. Helmeted police at Little Union Baptist Church on September 22, 1963. Image courtesy of Adam Fairclough's *Race and Democracy: The Civil Rights Struggle in Louisiana 1915-1972*. Original photo taken by Langston McEachern.

Figure 14. Students at Booker T. Washington High School run from a tear gas bomb on September 23, 1963. Image courtesy of Adam Fairclough's *Race and Democracy: The Civil Rights Struggle in Louisiana 1915-1972*. Original photo taken by Lloyd Stilley and housed at The Noel Memorial Library at LSU Shreveport.

Figure 15. *Shreveport Times* Article from 2013 recapping the Civil Rights Movement in Shreveport. Includes an image of Public Safety Commission George D'Artois. Image courtesy of the *Shreveport Times* online.

Figure 16. *Life* magazine, October 16, 1950, article "New Schools: US is Building Some Fine Ones But is Facing a Serious Shortage," featuring Booker T. Washington High School in Shreveport. Image courtesy of Google Books.

Figure 17. Photograph of Rev. Harry Blake and Shreveport policemen prior to the march planned for September 22, 1963. Image courtesy of Noel Library, LSU-Shreveport.

Figure 18. Booker T. Washington students participating in a march on September 23, 1963. Image courtesy of Noel Library, LSU-Shreveport.

Figure 19. Booker T. Washington students running from police during a march on September 23, 1963. Image courtesy of Noel Library, LSU-Shreveport.

Figure 20. A Booker T. Washington student is chased by a Shreveport policeman during a march on September 23, 1963. Image courtesy of Noel Library, LSU-Shreveport.

Figure 21. Booker T. Washington students flee from police after they released tear gas on the students during a march on September 23, 1963. Image courtesy of Noel Library, LSU-Shreveport.

Booker T. Washington High School

Name of Property

Caddo Parish, Louisiana

County and State

Figure 22. Shreveport Police gather at Booker T. Washington High School on September 23, 1963. Image courtesy of Noel Library, LSU-Shreveport.

Figure 23. Booker T. Washington students flee police after tear gas was released during a march on September 23, 1963. Image courtesy of Noel Library, LSU-Shreveport.

Figure 24. Booker T. Washington students flee police after tear gas was released during a march on September 23, 1963. Image courtesy of Noel Library, LSU-Shreveport.

Figure 25. Booker T. Washington students participating in a march on September 23, 1963. Image courtesy of Noel Library, LSU-Shreveport.

Figure 26. Police prepare to head towards Little Union Baptist Church on September 22, 1963. Image courtesy of Noel Library, LSU-Shreveport.

Figure 27. Shreveport police gather at Little Union Baptist Church on September 22, 1963. Image courtesy of Noel Library, LSU-Shreveport.

Figure 28. Shreveport police gather at Little Union Baptist Church on September 22, 1963. Image courtesy of Noel Library, LSU-Shreveport.

Figure 29. Police arrest a Booker T. Washington High School teacher following a march on September 23, 1963. Image courtesy of Noel Library, LSU-Shreveport.

Figure 30. Public Commissioner D'Artois speaks to Caddo Parish sheriff's deputies outside of Little Union Baptist Church on September 22, 1963. Image courtesy of Noel Library, LSU-Shreveport.

Figure 31. Public Commissioner D'Artois and Caddo Parish sheriff's deputies outside of Little Union Baptist Church on September 22, 1963. Image courtesy of Noel Library, LSU-Shreveport.

Figure 32. Public Commissioner D'Artois and Caddo Parish sheriff's deputies outside of Booker T. Washington High School on September 23, 1963. Image courtesy of Noel Library, LSU-Shreveport.

Figure 33. Rev. Harry Blake and a Shreveport policeman outside of Little Union Baptist Church on September 22, 1963. Image courtesy of Noel Library, LSU-Shreveport.

Figure 34. Rev. Harry Blake following a beating he endured during the police event at Little Union Baptist Church on September 22, 1963. Image courtesy of Noel Library, LSU-Shreveport.

Booker T. Washington High School
Name of Property

Caddo Parish, Louisiana
County and State



Figure 1: BTW HS Under-construction Aerial View ca1949-1950.

Booker T. Washington High School
Name of Property

Caddo Parish, Louisiana
County and State



Figure 2: BTW HS Under-construction ca1949-1950 (A).

Booker T. Washington High School
Name of Property

Caddo Parish, Louisiana
County and State



Figure 3: BTW HS Under-construction ca1949-1950 (B)

Booker T. Washington High School
Name of Property

Caddo Parish, Louisiana
County and State



Figure 4: BTW HS Under-construction September 1949 (Photographer: H.O. Wiseman)

Booker T. Washington High School
Name of Property

Caddo Parish, Louisiana
County and State



Figure 5: BTW HS Finishing Construction September 1949 (Photographer: H.O. Wiseman)

Booker T. Washington High School
Name of Property

Caddo Parish, Louisiana
County and State



Figure 6: BTW HS Finishing Construction ca1949-1950 (A)

Booker T. Washington High School
Name of Property

Caddo Parish, Louisiana
County and State



Figure 7: BTW HS Finishing Construction ca1949-1950 (B)

Booker T. Washington High School
Name of Property

Caddo Parish, Louisiana
County and State



Figure 8: BTW HS Exterior View Front Elevation September 1950 (Photographer: William A. Bains)

Booker T. Washington High School
Name of Property

Caddo Parish, Louisiana
County and State



Figure 9: BTW HS Main Entrance no date (Photographer: William A. Bains)

Booker T. Washington High School
Name of Property

Caddo Parish, Louisiana
County and State



Figure 10: BTW HS Exterior View (from Milam Street) no date

Booker T. Washington High School
Name of Property

Caddo Parish, Louisiana
County and State



Figure 11: BTW HS Shreveport Police on BTW HS Campus, April 23, 1963 (Photographer: Shreveport Police Department)

Booker T. Washington High School
Name of Property

Caddo Parish, Louisiana
County and State

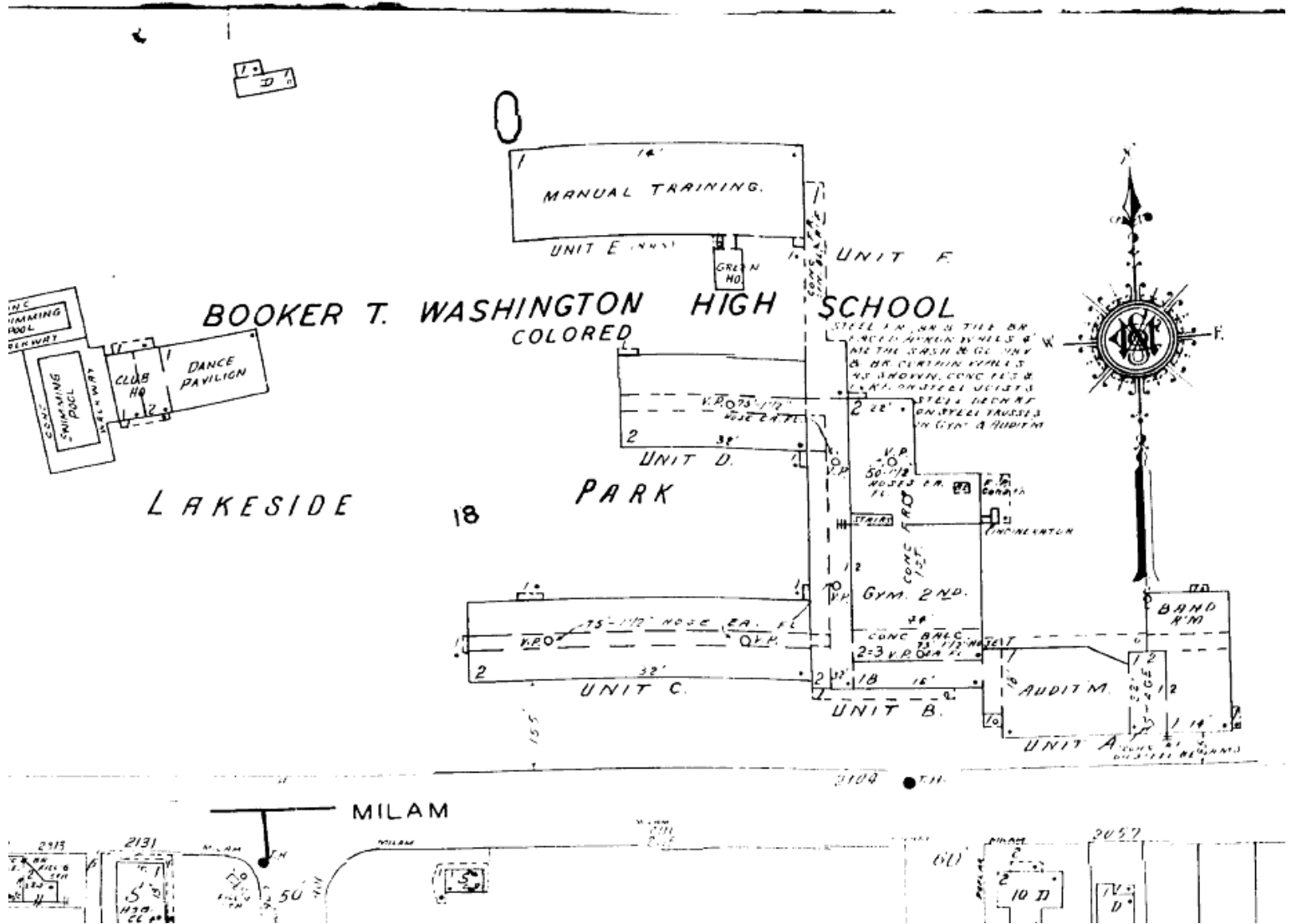

Figure 12: 1963 Sanborn Fire Map showing Booker T. Washington High School. Image courtesy of the State Library of Louisiana Digital Sanborn Map Collection.

Booker T. Washington High School
Name of Property

Caddo Parish, Louisiana
County and State



Figure 13. Helmeted police at Little Union Baptist Church on September 22, 1963. Image courtesy of Adam Fairclough's *Race and Democracy: The Civil Rights Struggle in Louisiana 1915-1972*. Original photo taken by Langston McEachern.

Booker T. Washington High School
Name of Property

Caddo Parish, Louisiana
County and State



Figure 14. Students at Booker T. Washington High School run from a tear gas bomb on September 23, 1963. Image courtesy of Adam Fairclough's *Race and Democracy: The Civil Rights Struggle in Louisiana 1915-1972*. Original photo taken by Lloyd Stilley and housed at The Noel Memorial Library at LSU Shreveport.

Booker T. Washington High School
Name of Property

Caddo Parish, Louisiana
County and State

THE TIMES • shreveporttimes.com

SUNDAY, FEBRUARY 17, 2013 5A

CIVIL RIGHTS MOVEMENT: 50 YEARS LATER

Civil

Continued from Page 4
senseless by several police officers. A copy of a photo taken by veteran Shreveport photographer Courtland Milloy Sr. hangs in a hallway at Mount Canam, along with an apology given years later by the Shreveport City Council.
"I don't look at it," Blake says today, 50 years later. "Who goes around talking about 'Man, I got my head split open?' I never thought of it as being outrageous, I just knew... what I saw happening in my local community and what happened in America, something was wrong with that. What can I do to change where I live?"
That was the only thing I had in mind. I didn't see it as making history, something I needed to keep a record of."

The day after the Little Union melee, a larger crowd, including many students from Booker T. Washington High School, demonstrated again. After demonstrating outside the school the students were forced back inside by police and deputies, and a standoff ensued.

"At one point after the march was quelled and police moved on to Booker T. Washington, the high school looked as if it were a fortress under siege," the next day's story in The Times read. "The yelling students were throwing objects, including soft drink bottles, from second floor windows at the police."

When students came out to march down Milam Street, "police tossed a tear gas bomb into a group of between 50 and 80 youths," the report continues.

Eventually, the school principal and a local minister, after conferring with D'Artois, convinced police and deputies to regroup at the old SPAR Stadium, and that defused the situation. In all, 16 people were arrested, and five of the students were injured.

The next day, a third, smaller and shorter but more intense demonstration occurred at J.S. Clark Junior High School, where students threw rocks at cars, including that of D'Artois.

That demonstration eventually petered out after black police officers were sent in, and no arrests or injuries are noted in The Times' files. However, the incidents here were telegraphed by the NAACP in Dallas to President John F. Kennedy.

Shreveport "probably is one of the most explosive cities in the country," NAACP Dallas Regional Executive Clarence Laws was quoted in his request for federal intervention here.

Simpkins, now 83 and retired from dentistry, believes Shreveport is "a lot better off now than we were then." Still, the gains made and the work done needs to be taken forward without rancor, he said.

"We need to start caring more about each other and



Shreveport Public Safety Commissioner George D'Artois (in dark suit) confers with top local law officials outside a memorial service at the Little Union Baptist Church on Sept. 22, 1963. D'Artois had refused a permit to hold a memorial march for four girls killed in a bomb blast in Birmingham, Ala., several days earlier. When people showed up at the church and it appeared a march would be held anyway, a tense confrontation ensued. *STC/GAL TO THE TIMES*

DOCUMENTARY

Local filmmaker and historian Joley Kent and director Tiri DeWayne have produced a documentary that takes a look at Shreveport's long road to civil rights. "Beyond Galilee" featured interviews with more than 20 people involved in the local Civil Rights movement and showcases Shreveport's vital role in the national civil rights effort. A number of screenings will be offered in coming weeks. Tickets at all venues are \$9.
Here are dates and times, by venue:
■ Robinson Film Center, 617 Texas St., noon Saturday
■ Louisiana State Exhibit Museum, 3015 Greenwood Road, 5 p.m. Feb. 24 and March 3, 9 and 10, and at 2 p.m. and 7 p.m. March 2.
Learn more about the documentary, its creators and the civil rights effort in Shreveport at www.beyondgalilee.com and @shreveporttimes.com

build on the future and forget the past that has difficulty," he said. "Remember the future and work for the future. Have faith that things can change. Keep the faith. You have got to have faith and you have to have forgiveness."
Blake also sees improvement and a continued need to strive for better.
"We've come through some turbulent times to this time, and a lot of things we sought to accomplish have been accomplished, but there is a new set of challenges for this day and age," he said. "The civil rights movement — sit ins and what have you — was about opening the right for blacks to sit where they were accommodated, not just reserved sections, and that

has been accomplished. The race thing is still before us, but not as blatant as it was during those days. We've got to work on loving each another and living in peace and harmony in America."
Ann Brewster shot herself in late February 1964. She was in her early 40s.

Her hand-written suicide note is stapled to the coroner's report that now is preserved in the Noel Archives at LSU Shreveport.

"I am tired so so tired I cannot go on any longer," she wrote in her final message. "I am so sorry. But I just can't go on Negroes in Shreveport please stand up please support your people that's in this struggle. ... I can't go on. We must We shall overcome." (SIC)
Sullivan, jailed with Brew-

ster, has visited Shreveport often and returned from 1983 to 1992 to work at Southern University and the Shreveport Chamber of Commerce. He agrees things have changed for the better, and the city today is one Brewster might not recognize. It has a black mayor, a black chief of police, a black city marshal and the U.S. Marshal also is black. Numerous other civic, judicial, business and social leaders also are black.

"I was amazed by the improvements," he said. "I knew there were still some problems, but it was light years ahead of what had happened, what was going on when I was there."

But he always will remember his time in jail here and his 18th birthday.

"Because we were sit-in demonstrators, the folks were different, they were almost — we were honored," he remembered. "We had one guy who came up to us and said, 'Man, I've shot people, robbed, I've even killed, but I ain't going to sit in at no white lunch counter. We were looked at as pretty nervous folks. They hadn't the nerve to sit at a white lunch counter because they knew what would happen back in that day, once they got up to the jailhouse. But we had the publicity and all that.'"

TIMELINE OF CIVIL RIGHTS, INCLUDING LOUISIANA AND SHREVEPORT

- 1955 — Martin Luther King Jr. and Rosa Parks gain national attention in boycott of city bus lines in Montgomery, Ala. The protest sparks the modern civil rights movement.
- 1957 — Central High School integrated: Under armed guards, nine black students entered Central High School in Little Rock, Ark., on Sept. 24. It was the first Southern school to undergo formal integration. In Louisiana, the legislative fight integration: Gov. Earl K. Long eventually signs a bill giving him power to close schools threatened with integration. In Shreveport, several local black residents sue the Shreveport Trade School for integration policies.
- 1960 — Group of white and black students protest segregation by holding sit-ins at white-only lunch counters in Greensboro, N.C.
- Shreveport Trade School integrated. Two-supported, tuition-free school on Hope Street ordered to admit black students. New Orleans schools are integrated. Ordean are burned in Shreveport in front of all-black Booker T. Washington High School and the Caddo Parish School Board office.
- 1961 — Freedom Riders try to desegregate Trailways bus stations in Shreveport; arrests are made.
- 1962 — Negro camps on Lake Bistineau are bombed. Catholic archbishop of New Orleans communicates three vocal segregationist leaders, including state Democratic political boss and former district Judge Leander Perez.
- 1963 — Birmingham riots, police beatings of protesters and King's arrest lead President John F. Kennedy to send 3,000 troops to Alabama. 250,000 "Freedom Marchers" descend on Washington, D.C. King delivers "I Have a Dream" speech. In Shreveport, sit-ins are staged at local Woolworth's, Walgreens and Sears lunch counters, with arrests; in September, standoffs with police and deputies occur at Booker T. Washington High School, Little Union Baptist Church and J.S. Clark Junior High School, with arrests and some injuries.
- 1964 — Civil Rights Act passes, and provisions for all schools to integrate or lose federal funding. Bossier segregation challenged after two black mothers try to enroll their five children in all-white Kerr Elementary School.
- 1965 — Caddo segregation challenged by the Rev. L. Edward Jones, who files suit on behalf of his daughter, Beryl, calling for desegregation of Caddo Parish schools. Arthur Burton, Brenda Briggs and Beryl Jones become the first black students to attend an all-white school in Caddo Parish.
- 1967 — President Lyndon B. Johnson appoints Thurgood Marshall as first black justice on the Supreme Court. Bossier schools desegregate.
- 1968 — The Rev. Martin Luther King Jr. assassinated at Memphis motel. James Earl Ray is captured in London and convicted of murder.
- 1972 — Another suit is filed on behalf of Beryl N. Jones, charging the Caddo School Board with "failing to implement a court-ordered non-discriminatory, unitary school system."
- 1973 — District court appoints a biracial committee to prepare a desegregation plan for Caddo Parish schools. That plan, which called for an equal ratio of black and white teachers, an increase in the number of black administrators and improvement of programs, is approved by the court in the same year.
- 1978 — U.S. Justice Department files motion saying Caddo has too many one-race schools.
- 1981 — Caddo Parish School Board and the U.S. Justice Department enter into an agreement known as the Consent Decree. It calls for closure of certain all-black schools, opening of certain integrated schools, establishment of several magnet programs and magnet schools, as well as non-discriminatory hiring practices and minority transfers.
- 1983 — Darren Lyon Martin's murder at the Hot Biscuit Restaurant in Shreveport was ruled racially motivated.
- 1985 — Foot breaks out in Cedar Grove neighborhood of Shreveport after looting of William Dawkins McKinley.
- 1989 — Former KKK member David Dallas wins election to state Legislature.
- 1990 — Unlighted gasoline-soaked cross stands on the Blanchard lawn of a black family. Two youths (age 16 and 17) charged with misdemeanor criminal mischief, littering and simple obstruction of justice.
- 1991 — Nine crosses burn in integrated and predominantly black areas of Shreveport.
- 1991 — David Duke makes runoff for governor. Defeated in a runoff with Edwin Edwards.
- 1992 — Swastika, anti-gay and kneecap graffiti are spray-painted outside a gay bar, synagogue, two businesses owned by Jews and an office park with many Jewish occupants. The Shreveport bar and synagogue receive telephone threats. Three teens arrested.
- First vice president Jerry Tim Brooks accuses the Caddo Parish School Board of racism when Judy Boykin is elected president instead of him. Traditionally, the first vice president is elected president. But a majority voted for two-year board member Judy Boykin of District 10.
- 1993 — A dozen Ku Klux Klan members hold informational rally at the Caddo Parish Courthouse.
- 1994 — Five Bossier City Public Works Department employees file a federal lawsuit against Bossier City and Pels Glonzo for discriminatory hiring and promotions practices.
- 1996 — Gov. Mike Foster signs executive order to end minority-based set-asides and affirmative action. More than 6,000 people rally in Baton Rouge against Foster's stand on affirmative action and minority set-aside programs. A building in the 1300 block of Milam Street in Shreveport that is scheduled to become the new home of the predominantly black New Birth Temple Church of God in Christ is damaged in a fire deemed to be arson.
- 2006 — Cedric Glover elected Shreveport's first black mayor.
- 2008 — Barack Obama elected nation's first president of color.
- 2010 — Cedric Glover re-elected Shreveport mayor.
- 2012 — Barack Obama re-elected.



"I knew that what was the situation then was not what it should be. I just wanted things to get better."

HENRY L. SULLIVAN JR.
Arrested in July 1963 in a sit-in at a segregated downtown lunch counter

Figure 15. Shreveport Times Article from 2013 recapping the Civil Rights Movement in Shreveport. Includes an image of Public Safety Commission George D'Artois. Image courtesy of the Shreveport Times online.

Booker T. Washington High School
Name of Property

Caddo Parish, Louisiana
County and State



Figure 16. *Life* magazine, October 16, 1950, article "New Schools: US is Building Some Fine Ones But is Facing a Serious Shortage," featuring Booker T. Washington High School in Shreveport. Image courtesy of Google Books.

Booker T. Washington High School
Name of Property

Caddo Parish, Louisiana
County and State



Figure 17. Photograph of Rev. Harry Blake and Shreveport policemen prior to the march planned for September 22, 1963. Image courtesy of Noel Library, LSU-Shreveport.

Booker T. Washington High School
Name of Property

Caddo Parish, Louisiana
County and State



Figure 18. Booker T. Washington students participating in a march on September 23, 1963. Image courtesy of Noel Library, LSU-Shreveport.

Booker T. Washington High School
Name of Property

Caddo Parish, Louisiana
County and State



Figure 19. Booker T. Washington students running from police during a march on September 23, 1963. Image courtesy of Noel Library, LSU-Shreveport.

Booker T. Washington High School
Name of Property

Caddo Parish, Louisiana
County and State



Figure 20. A Booker T. Washington student is chased by a Shreveport policeman during a march on September 23, 1963. Image courtesy of Noel Library, LSU-Shreveport.

Booker T. Washington High School
Name of Property

Caddo Parish, Louisiana
County and State



Figure 21. Booker T. Washington students flee from police after they released tear gas on the students during a march on September 23, 1963. Image courtesy of Noel Library, LSU-Shreveport.

Booker T. Washington High School
Name of Property

Caddo Parish, Louisiana
County and State



Figure 22. Shreveport Police gather at Booker T. Washington High School on September 23, 1963. Image courtesy of Noel Library, LSU-Shreveport.

Booker T. Washington High School
Name of Property

Caddo Parish, Louisiana
County and State



Figure 23. Booker T. Washington students flee police after tear gas was released during a march on September 23, 1963. Image courtesy of Noel Library, LSU-Shreveport.

Booker T. Washington High School
Name of Property

Caddo Parish, Louisiana
County and State



Figure 24. Booker T. Washington students flee police after tear gas was released during a march on September 23, 1963. Image courtesy of Noel Library, LSU-Shreveport.

Booker T. Washington High School
Name of Property

Caddo Parish, Louisiana
County and State



Figure 25. Booker T. Washington students participating in a march on September 23, 1963. Image courtesy of Noel Library, LSU-Shreveport.

Booker T. Washington High School
Name of Property

Caddo Parish, Louisiana
County and State



Figure 26. Police head towards Little Union Baptist Church on September 22, 1963. Image courtesy of Noel Library, LSU-Shreveport.

Booker T. Washington High School
Name of Property

Caddo Parish, Louisiana
County and State



Figure 27. Shreveport police gather at Little Union Baptist Church on September 22, 1963. Image courtesy of Noel Library, LSU-Shreveport.

Booker T. Washington High School
Name of Property

Caddo Parish, Louisiana
County and State



Little Union Baptist Church - September 22, 1963

Figure 28. Shreveport police gather at Little Union Baptist Church on September 22, 1963. Image courtesy of Noel Library, LSU-Shreveport.

Booker T. Washington High School
Name of Property

Caddo Parish, Louisiana
County and State



Figure 29. Police arrest a Booker T. Washington High School teacher following a march on September 23, 1963. Image courtesy of Noel Library, LSU-Shreveport.

Booker T. Washington High School
Name of Property

Caddo Parish, Louisiana
County and State



Figure 30. Public Commissioner D'Artois speaks to Caddo Parish sheriff's deputies outside of Little Union Baptist Church on September 22, 1963. Image courtesy of Noel Library, LSU-Shreveport.

Booker T. Washington High School
Name of Property

Caddo Parish, Louisiana
County and State



Figure 31. Public Commissioner D'Artois and Caddo Parish sheriff's deputies outside of Little Union Baptist Church on September 22, 1963. Image courtesy of Noel Library, LSU-Shreveport.

Booker T. Washington High School
Name of Property

Caddo Parish, Louisiana
County and State



Booker T. Washington - September 23, 1963

Figure 32. Public Commissioner D'Artois and Caddo Parish sheriff's deputies outside of Booker T. Washington High School on September 23, 1963. Image courtesy of Noel Library, LSU-Shreveport.

Booker T. Washington High School
Name of Property

Caddo Parish, Louisiana
County and State



Figure 33. Rev. Harry Blake and a Shreveport policeman outside of Little Union Baptist Church on September 22, 1963. Image courtesy of Noel Library, LSU-Shreveport.

Booker T. Washington High School
Name of Property

Caddo Parish, Louisiana
County and State



Figure 34. Rev. Harry Blake following a beating he endured during the police event at Little Union Baptist Church on September 22, 1963. Image courtesy of Noel Library, LSU-Shreveport.

Paperwork Reduction Act Statement: This information is being collected for applications to the National Register of Historic Places to nominate properties for listing or determine eligibility for listing, to list properties, and to amend existing listings. Response to this request is required to obtain a benefit in accordance with the National Historic Preservation Act, as amended (16 U.S.C.460 et seq.).

Estimated Burden Statement: Public reporting burden for this form is estimated to average 100 hours per response including time for reviewing instructions, gathering and maintaining data, and completing and reviewing the form. Direct comments regarding this burden estimate or any aspect of this form to the Office of Planning and Performance Management, U.S. Dept. of the Interior, 1849 C. Street, NW, Washington, DC.

Booker T. Washington High School, Caddo Parish, LA



Latitude: 32.504336 Longitude: -93.774010

Booker T. Washington High School, Caddo Parish, LA

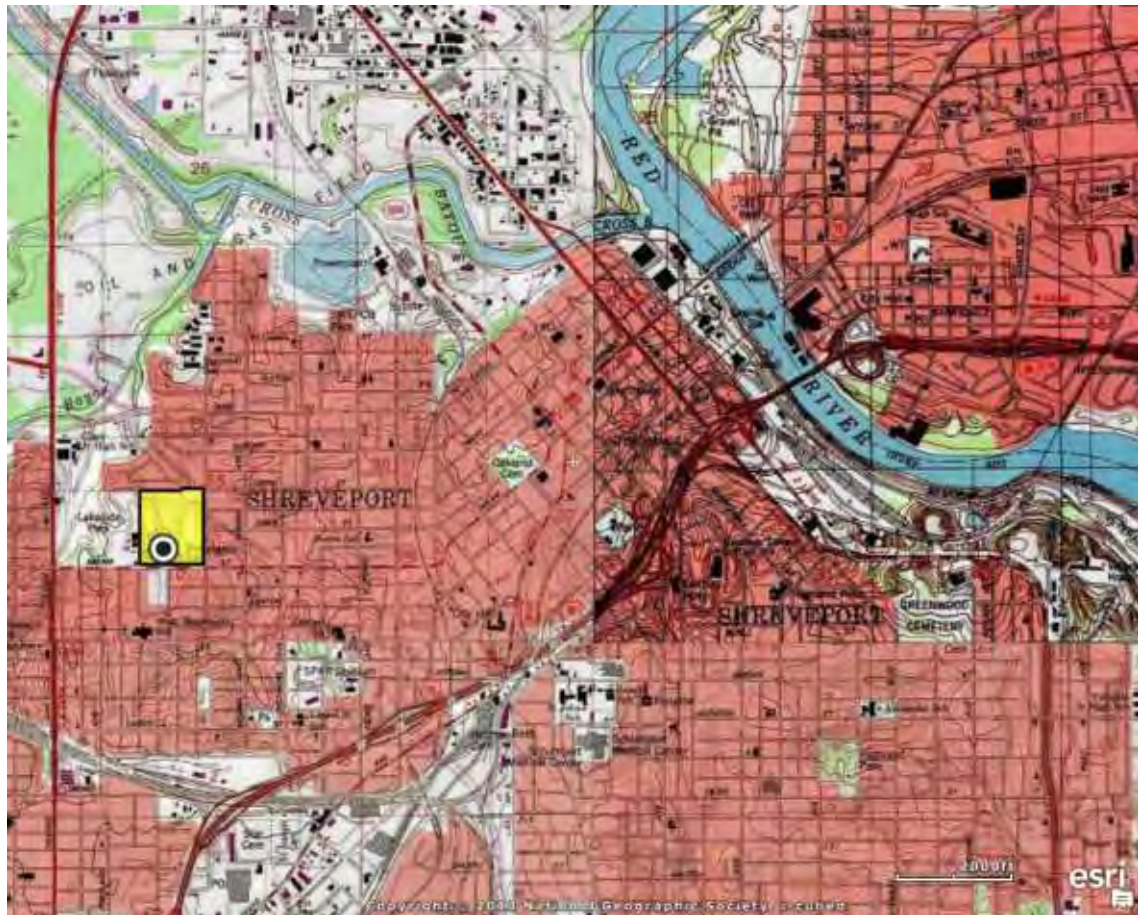

Latitude: 32.504336 Longitude: -93.774010

Booker T. Washington High School, Caddo Parish, LA

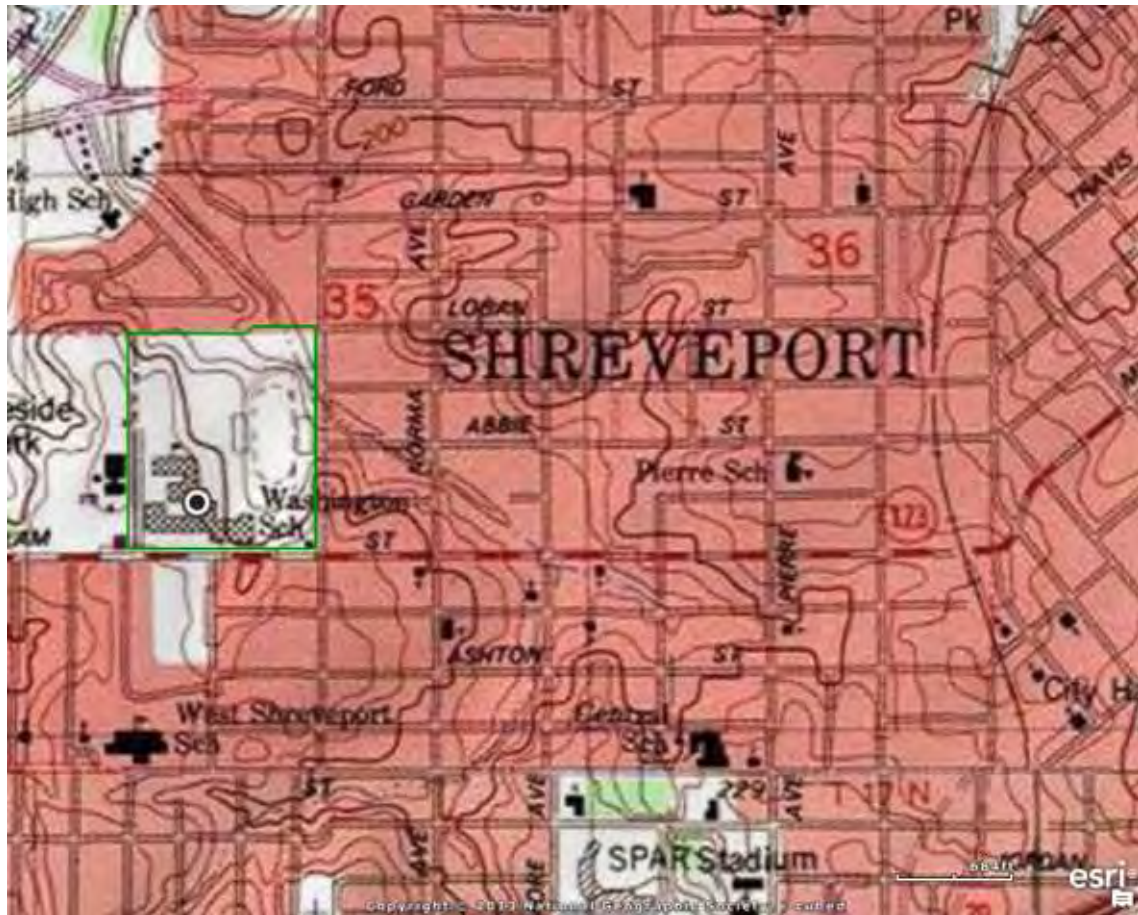

Latitude: 32.504336 Longitude: -93.774010

Booker T. Washington High School, Caddo Parish, LA

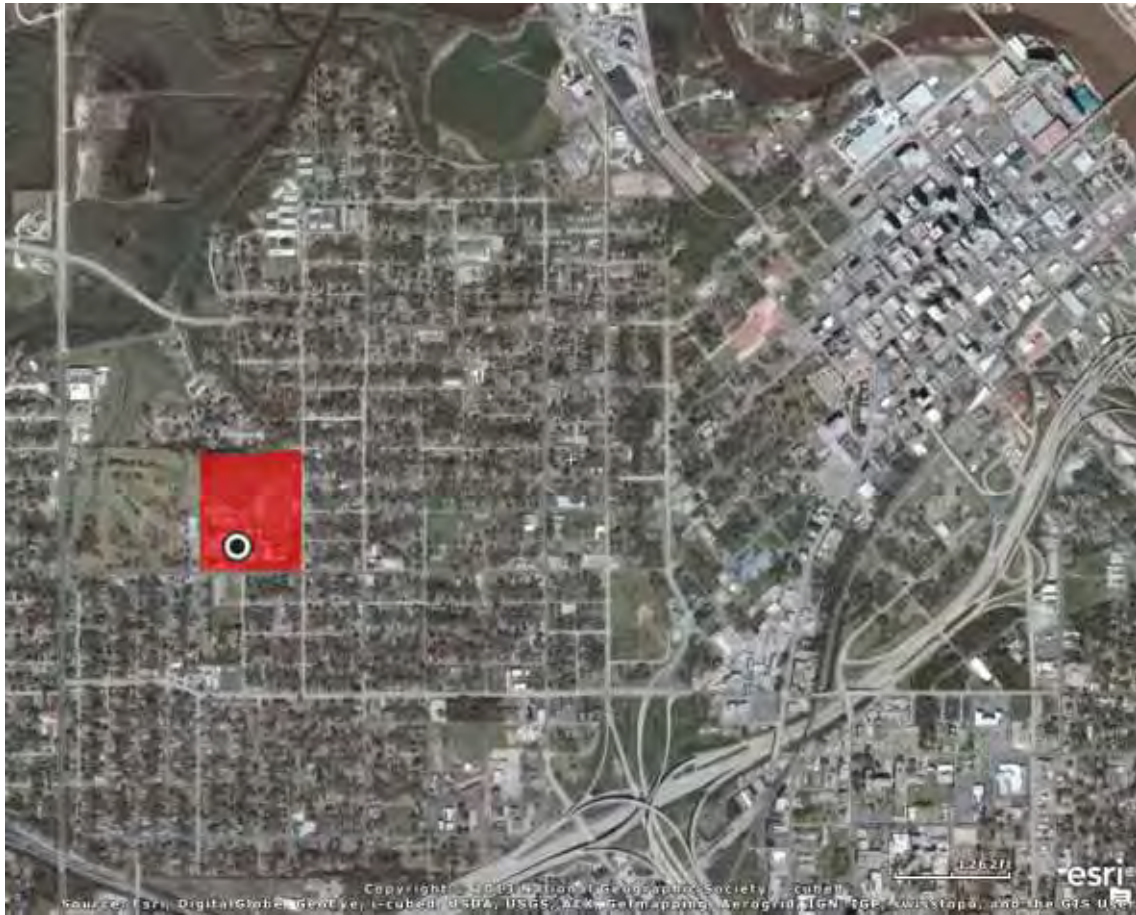

Latitude: 32.504336 Longitude: -93.774010

Booker T. Washington High School, Caddo Parish, LA



1. Latitude: 32.503593 Longitude: -93.771745
2. Latitude: 32.503590 Longitude: -93.775322
3. Latitude: 32.507062 Longitude: -93.775323
4. Latitude: 32.507050 Longitude: -93.773067
5. Latitude: 32.507166 Longitude: -93.772937
6. Latitude: 32.507165 Longitude: -93.771746

- Non-contributing Building
- Non-contributing Structure
- Boundary

Booker T. Washington High School
Caddo Parish, LA
Exterior Photo Sketch Map and
Contributing/Non-Contributing Map

- Non-contributing Site
- Contributing Building
- Alteration/Addition

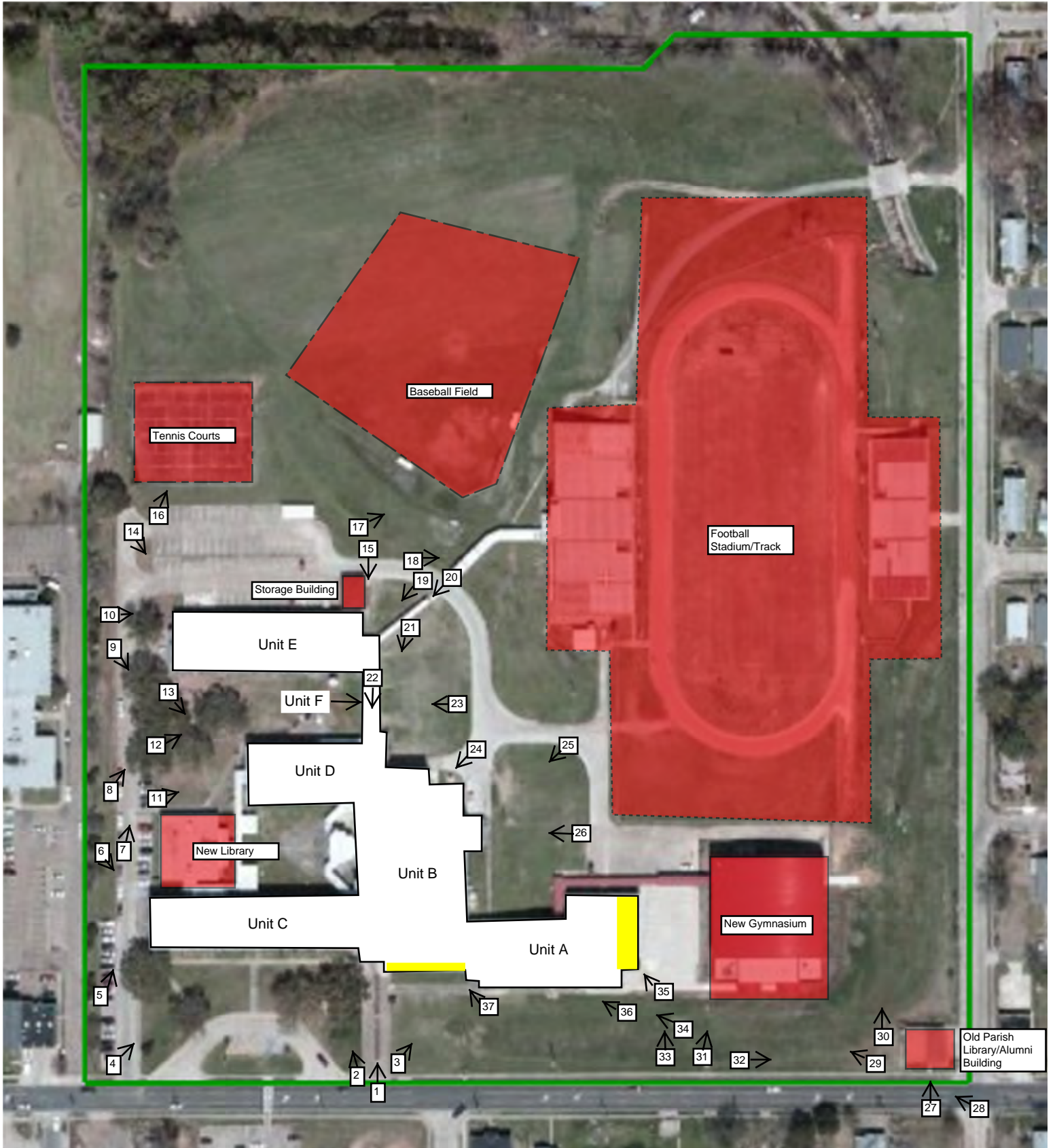



Booker T. Washington High School Caddo Parish, LA Interior Sketch Map

Note: Not to Scale & stairwells are not shown ; Photos 41 and 42 are of two of the main school building's stairwells

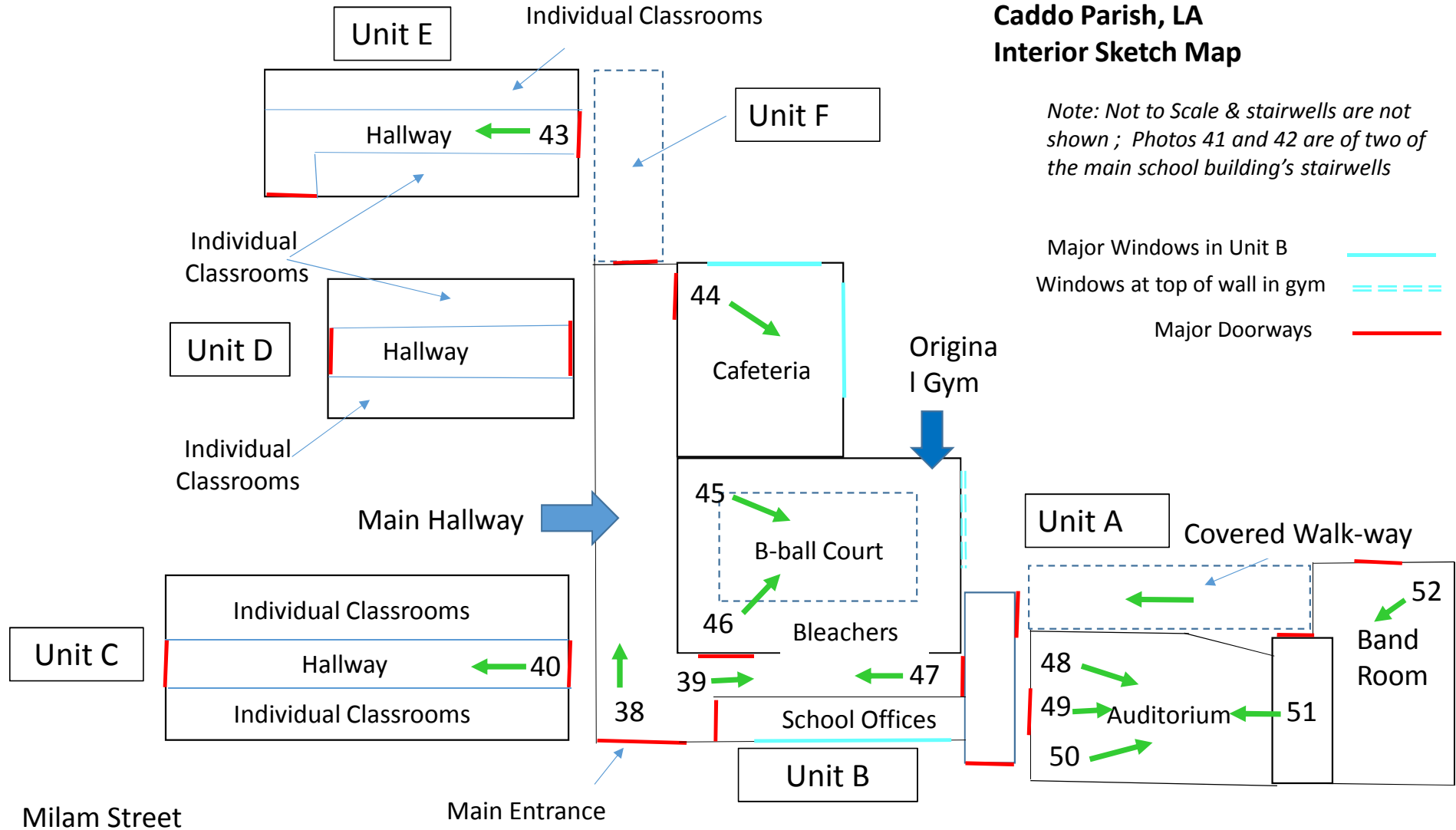



BOOKER T. WASHINGTON
HIGH SCHOOL





BOOKER T. WASHINGTON
HIGH SCHOOL









SPEED
LIMIT
5







NO PARKING





NO
PARKING
ENTER
LANE
ANY TIME

KEEP
OFF
GRASS

NO PARKING







NO
PARKING
EXCEPT FOR
EMERGENCY
VEHICLES





NO
PARKING
VIOLATORS
WILL BE
FINED
AT OWNER'S
EXPENSE





LION'S DEN



NO
PARKING

VIOLATORS
WILL BE
TOWED
AT OWNER'S
EXPENSE













NO
PARKING
VIOLATORS
WILL BE
TOWED
AT OWNER'S
RISK



2004

ROBERT L. WASHINGTON
HERITAGE & ACADEMIC CENTER

NO SMOKING
ALUMNI
BUILDING





ROBERT T. WASHINGTON
HERITAGE & ACADEMIC CENTER

ALUMNI
BUILDING



AHEAD

SCHOOL
ZONE

NO PARKING
ANY TIME
↔







ROBERT T. WASHINGTON
SCHOOL















WARNING
CAUTION
DO NOT TOUCH
OR REMOVE
THIS SIGN
OR THE INFORMATION
ON IT



THE LIONS' DEN
B.T. WASHINGTON HIGH SCHOOL

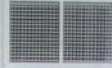

Path to
Excellence
School



alliance
to education

OLD
GYM





WU
WILKS-KNIGHTON
HEALTH SYSTEM
**Path to
Excellence
School**
ae
alliance
for education

Good
Character
by being
**DUE
FRIE!**
Caring
Citizenship
Creativity
Respect
Responsibility
Teamwork









E100

TV Studio 1 & 2
Hall
Room 2-100
Mr. S. Johnson



 THE LIONS' DEN
S.T. WASHINGTON HIGH SCHOOL





BTW
BETTER THAN
WATER

BTW
BETTER THAN
WATER

LET'S GET
THE MOST
OUT OF
THE COURT

CADDO STADIUM





Congratulations
Booker T. Washington High School
Students, Faculty, Administrators,
Staff, and Parents
"Continuing The Legacy"
Booker T. Washington High School
Alumni Foundation
7th School Year
2013



BTW

Congratulations
Booker T. Washington High School
Students, Faculty, Administrators,
Staff, and Parents
"Continuing The Legacy"
Booker T. Washington High School
Alumni Foundation
We Salute You!
2013



Congratulations
Robert T. Madigan High School
Student Body Administration
Staff and Faculty
"Carrying the Legacy"
Robert T. Madigan High School
Alumni Association
100 School Street
2011





UNITED STATES DEPARTMENT OF THE INTERIOR
NATIONAL PARK SERVICE

NATIONAL REGISTER OF HISTORIC PLACES
EVALUATION/RETURN SHEET

REQUESTED ACTION: NOMINATION

PROPERTY NAME: Washington, Booker T., High School

MULTIPLE NAME:

STATE & COUNTY: LOUISIANA, Caddo

DATE RECEIVED: 5/29/15 DATE OF PENDING LIST: 7/01/15
DATE OF 16TH DAY: 7/16/15 DATE OF 45TH DAY: 7/14/15
DATE OF WEEKLY LIST:

REFERENCE NUMBER: 15000414

REASONS FOR REVIEW:

APPEAL: N DATA PROBLEM: N LANDSCAPE: N LESS THAN 50 YEARS: N
OTHER: N PDIL: N PERIOD: N PROGRAM UNAPPROVED: N
REQUEST: Y SAMPLE: N SLR DRAFT: N NATIONAL: N

COMMENT WAIVER: N

ACCEPT RETURN REJECT 7.14.2015 DATE

ABSTRACT/SUMMARY COMMENTS:

Excellent example of Post War school Architecture - sleek, modern
lines; Division of space based on function; integration into terrain.
Also, as City's African-American High School, it served as
the nexus for a large Civil Rights Demonstration in 1962

RECOM./CRITERIA Accept A&C

REVIEWER J. Gabbert DISCIPLINE _____

TELEPHONE _____ DATE _____

DOCUMENTATION see attached comments Y/N Y see attached SLR Y/N Y

If a nomination is returned to the nominating authority, the nomination is no longer under consideration by the NPS.



the day of our meeting - April 14, 2015. I just scanned one page instead of mailing the whole thing. It has over 100 pages of signatures in support of the nomination.

Booker T. Washington High School Alumni Foundation
 P.O. Box 3709
 Shreveport, LA 71133-3709
 Email: btwhsalumnifoundation71103@gmail.com
 Facebook: [btwhsalumnifoundation](https://www.facebook.com/btwhsalumnifoundation)

PETITION

WE SUPPORT BOOKER T. WASHINGTON HIGH SCHOOL IN BEING PLACED IN THE NATIONAL REGISTER OF HISTORIC PLACES.

NAME	ADDRESS	CITY, STATE, ZIP CODE	TELEPHONE	ALUMNI YEAR	FRIEND
Ronald Brown	2010 Ford	Shreveport	510-9986	1980	
Terrence Jones	102 Allen Ave	Shreveport		2004	
James Washington	123 Allen Ave.	Shreveport		2010	
Tammy Christ	742 March St	S. part	227 2524	1984	
Mathaniel Jones	1609 Westchester	Sp. at		1968	Friend
Anthony Bates	2723 murphy	Shreveport	573-3522	1997	
Andre West	2022 Talbot	Shreveport, LA	990-8554	2001	friend
Earl Jackson	1850 Alder St.	Shreveport, La 71101	946-2771		Friend
Ernest Jones	1635 Templeman St	Shreveport	227-3337	1955	
Bill Harris	6209 NOTTA	Shreveport, La		61	✓
Willie C White	1649 Templeman	Sp. at La 71101	766-762-6979	1985	✓

LOCAL OFFICIAL'S WAIVER

This is the owner waiver. The owner is the superintendent of the school board, Dr. Theodis "Lamar" Goree, Jr. - JR

February 9, 2015

Jessica Richardson, National Register Coordinator
PO Box 44247
Baton Rouge, LA 70804

Dear Ms. Richardson:

This will confirm that I am fully aware of the effects of listing a property in the National Register of Historic Places. I recognize that, under the National Historic Preservation Act, I am entitled to comment on the proposed listing of property within my jurisdiction.

Following is the address of the property within my jurisdiction that is currently under consideration for nomination to the National Register of Historic Places:

Booker T. Washington High School
2104 Milam St
Shreveport, LA 71103

I hereby waive my comment period for the nomination as provided for in the National Park Service's regulations (36 CFR Part 60).

Sincerely,

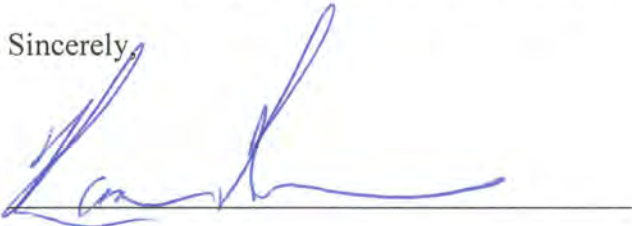

Notary Public
JENNIFER M. WHITAKER
NOTARY PUBLIC ID # 77158
MY COMMISSION IS FOR LIFE

LOCAL OFFICIAL'S WAIVER

February 9, 2015

Jessica Richardson, National Register Coordinator
PO Box 44247
Baton Rouge, LA 70804

Dear Ms. Richardson:

This will confirm that I am fully aware of the effects of listing a property in the National Register of Historic Places. I recognize that, under the National Historic Preservation Act, I am entitled to comment on the proposed listing of property within my jurisdiction.

Following is the address of the property within my jurisdiction that is currently under consideration for nomination to the National Register of Historic Places:

Booker T. Washington High School
2104 Milam St
Shreveport, LA 71103

I hereby waive my comment period for the nomination as provided for in the National Park Service's regulations (36 CFR Part 60).

Sincerely,

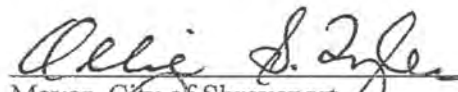

Mayor, City of Shreveport

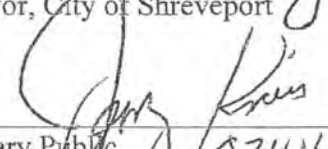

Notary Public 07416

JERRY KIRCUS
Notary Public, Caddo Parish, LA
My commission is for life



RECEIVED 2280

MAY 29 2015

Nat. Register of Historic Places
National Park Service

PAM BREAUX
ASSISTANT SECRETARY

JAY DARDENNE
LIEUTENANT GOVERNOR

State of Louisiana
OFFICE OF THE LIEUTENANT GOVERNOR
DEPARTMENT OF CULTURE, RECREATION & TOURISM
OFFICE OF CULTURAL DEVELOPMENT
DIVISION OF HISTORIC PRESERVATION

May 27, 2015

TO: Mr. James Gabbert
National Park Service 2280, 8th Floor; National Register of Historic Places
1201 "I" Street, NW; Washington, DC 20005

FROM: Jessica Richardson, National Register Coordinator
Louisiana Division of Historic Preservation

RE: Booker T. Washington High School, Caddo Parish, LA

Jim,

The enclosed disk contains the true and correct copy of the nomination for Booker T. Washington High School to the National Register of Historic Places. The second disk contains the photographs of the property in TIF format. Should you have any questions, please contact me at 225-219-4595 or jrichardson@crt.la.gov.

Thanks,

Jessica

Enclosures:

- CD with PDF of the National Register of Historic Places nomination form and Correspondence
- CD with electronic images (tif format)
- Physical Transmission Letter
- Physical Signature Page, with original signature
- _____ Other:

Comments:

- Please ensure that this nomination receives substantive review
- _____ This property has been certified under 36 CFR 67
- _____ The enclosed owner(s) objection(s) do _____ do not _____ constitute a majority of property owners.
- _____ Other:

JUN 15 2015

H34(2280)

Mr. Edgar Rogers, Chairman
Human Utilities Whole Armour
P.O. Box 37371
Shreveport, Louisiana 71133-7371

Dear Mr. Rogers:

Thank you for your inquiry requesting review of the Booker T. Washington High School in Caddo Parish, Louisiana, and its potential for National Historic Landmark (NHL) designation.

After reviewing the information submitted in your letter and the supplementary materials, we have determined that Booker T. Washington High School in Caddo Parish, Louisiana, does not meet program requirements for consideration as a National Historic Landmark. Whereas there are over 90,000 properties listed in the National Register of Historic Places only 2,556 of these properties are also designated as National Historic Landmarks by meeting a higher threshold of historic significance and integrity.

The Booker T. Washington High School does not meet the criteria for consideration under NHL Criterion 4 for architecture. This criterion encompasses "properties that embody the distinguishing characteristics of an architectural type specimen exceptionally valuable for a study of a period, style, or method of construction..." Booker T. Washington High School shares the same architectural style as many other high schools built in the United States after World War II. Additionally, one of the ways in which national significance is assessed by the NHL Program is a comparison with other similar resources in the United States. It would be the responsibility of the nomination preparer to provide a context within the nomination to justify the national significance of a particular resource representative of a style. Drafting a comparative context for this resource type would be almost impossible. Modern or International Style educational buildings are one of the most widespread resource types in the United States, making it difficult to assess the relative national significance of this particular school building. However, an argument can certainly be made at a local level of significance for listing in the National Register of Historic Places.

Properties that meet the criteria for designation as a National Historic Landmark under NHL Criterion 1 must "be associated with events that have made a significant contribution to, and are identified with, or that outstandingly represent, the broad national patterns of United States history." The letter of inquiry notes that Booker T. Washington was built as a modern educational facility for African American students in the 1940s. In 2000, the National Historic

Landmarks Program published a theme study titled *Civil Rights in America: Racial Desegregation in Public Education in the United States* as part of a series of studies addressing the topic of civil rights. On page 39 the study notes that: "As segregation tightened in the South during the early decades of the twentieth century, Dunbar High School in Washington, DC, defied the mandates of separated and unequal. Looking back on the illustrious history of the nation's first black public high school... 'Dunbar is the only example in our history of a separate black school that was able, somehow, to be equal.'" According to this National Park Service study, Dunbar High School was the only high school able to meet this threshold, meaning that Booker T. Washington High School did not meet the standard of separate but equal during this period.

In response to the 1956 *Brown v. Board of Education* decision that separate is not equal, Senator Harry Byrd authored the "Southern Manifesto," a petition signed by 100 Southern politicians vowing to defy the mandate by the United States Supreme Court to "integrate with all deliberate speed." As a result, schools throughout the South were closed to forestall integration. During this time, Booker T. Washington High School remained open and continued serving an exclusively African-American population with no attempts at integration; this in itself does not qualify the high school for consideration since it did not have a national impact. We encourage you to view the *Civil Rights in America: Racial Desegregation in Public Education in the United States* National Historic Landmark theme study online at http://www.nps.gov/nhl/learn/themes/CivilRights_DesegPublicEd.pdf, which outlines the types of properties that are eligible for consideration under this theme. Unfortunately, Booker T. Washington High School does not meet the criteria set forth in the study.

Lastly, the National Historic Landmarks Program designates properties that have the strongest association with a particular event. Booker T. Washington high school students marching in response to the Sixteenth Street Baptist Church bombing has a tangential association to the bomb site itself, which was designated as a National Historic Landmark in 2006. Part of the NHL evaluation process is assessing how the property under consideration compares to other comparable properties since the program only designates those properties that best represent a theme, as opposed to all properties representing a theme. The march by the high school students would have to be compared with the famous "Children's Crusade" march where Bull Connor attacked the children with fire hoses and dogs. The march in Shreveport by the high school students does not seem to possess the high level of national significance required of potential National Historic Landmarks.

We do, however, encourage you to consider listing in the National Register of Historic Places at the local or state level of significance. To start the listing process, please contact your State Historic Preservation Office at www.ncshpo.org.

We regret that we cannot be more encouraging. For further information on the National Historic Landmarks Program please visit our website at <http://www.nps.gov/nhl>. The National Park Service appreciates your work to preserve and protect our nation's heritage.

Sincerely,

James A. Jacobs

James A. Jacobs, Ph.D.
Acting Branch Chief
National Historic Landmarks Program

cc: Louisiana/SHPO

bcc: SERO, C. Walton
2280 Loether, Gabbert
2280 Booker T. Washington High School (Louisiana) (OSC)
Basic File Retained In 2280
FNP:Cdelavega:/OP/06/04/2015:S:\NR-NHL\NHL Negative Review\Booker T. Washington
High School\Booker T Washington HS Review